

STA700 SmartLine Absolute Pressure Specification 34-ST-03-120, November 2016



Introduction

Part of the SmartLine® family of products, the STA700 Dual Head and STA700 In-Line models are suitable for monitoring, control and data acquisition. STA700 Dual Head products feature piezoresistive sensor technology combining pressure sensing with on chip temperature compensation capabilities providing high accuracy, stability and performance over a wide range of application pressures and temperatures. The SmartLine family is also fully tested and compliant with Experion® PKS providing the highest level of compatibility assurance and integration capabilities. SmartLine easily meets the most demanding application needs for pressure measurement applications.

Best in Class Features:

- Accuracy up to 0.065 % of calibrated span
- Stability up to 0.025% of URL per year for five years
- Automatic temperature compensation
- Rangeability up to 100:1
- Response times as fast as 100ms
- Easy to use and intuitive display capabilities
- Intuitive external zero, span, & configuration capability
- On-board diagnostic capabilities
- Integral Dual Seal design for safety based on ANSI/NFPA 70-202 and ANSI/ISA 12.27.0
- Full compliance to SIL 2/3 requirements as a standard.

Communications/Output Options:

- HART® (version 7.0)



Figure 1 – STA700 InLine and Dual Head Absolute Pressure Transmitters

Span & Range Limits:

Model	URL mmHgA (mbarA)	LRL mmHgA (mbarA)	Min Span mm HgA (mbarA)	MAWP mmHgA (mbarA)
STA725/72S	780 (1040)	0 (0)	50 (65.0)	780 (1040)
Model	psia (barA)	psi (barA)	psi (barA)	psia (barA)
STA745/74S	500 (35)	0 (0)	5 (.35)	500 (35)
STA77S	3000 (210)	0 (0)	30 (2.1)	3000 (210)

Description

The SmartLine family pressure transmitters are designed around a high performance piezo-resistive sensor. This one sensor actually integrates multiple sensors linking process pressure measurement with on-board static pressure (DP Models) and temperature compensation measurements.

Indication/Display Option

Standard LCD Display Features

- Modular (may be added or removed in the field)
- Supports HART protocol variant
- 0, 90, 180, & 270 degree position adjustments
- Configurable (HART only) and standard (Pa, KPa, MPa, KGcm², Torr, ATM, inH₂O, mH₂O, bar, mbar, inHG, FTH₂O, mmH₂O, mm HG, & psi) measurement units.
- 2 Lines 6 digits PV (9.95H x 4.20W mm) 8 Characters
- Write protect Indication
- Built in Basic Device Configuration through Internal or External Buttons – Range/Engineering Unit/Loop Test /Loop Calibration/Zero /Span Setting

Diagnostics

SmartLine transmitters all offer digitally accessible diagnostics which aid in providing advanced warning of possible failure events minimizing unplanned shutdowns, providing **lower overall operational costs**

System Integration

- SmartLine communications protocols all meet the most current published standards for HART.
 - All ST 700 units are Experion tested to provide the highest level of compatibility assurance

Configuration Tools

External two button option for zero/span setting

Suitable for all electrical and environmental requirements, SmartLine offers the ability to configure the transmitter and display, for all basic parameters, via two externally accessible buttons when a display option is selected. Zero/span capabilities are also optionally available via two external buttons with or without selection of the display option.

Internal Two Button Configuration Option

The Standard display has two buttons that can be used for Basic configuration such as re ranging, PV Engineering unit setting, Zero/Span settings, Loop testing and calibration functions

Hand Held Configuration

SmartLine transmitters feature two-way communication and configuration capability between the operator and the transmitter. This is accomplished via Honeywell's field-rated Multiple Communication Configurator (MCT404).

The MCT404 is capable of field configuring DE and HART Devices and can also be ordered for use in intrinsically safe environments. All Honeywell transmitters are designed and tested for compliance with the offered communication protocols and are designed to operate with any properly validated hand held configuration device.

Personal Computer Configuration

Field Device Manager (FDM) Software and FDM Express are also available for managing HART device configurations.

Modular Design

To help contain maintenance & inventory costs, all ST 700 transmitters are modular in design supporting the user's ability to replace meter bodies, standard displays or electronic modules without affecting overall performance. Each meter body is uniquely characterized to provide in-tolerance performance over a wide range of application variations in temperature and pressure.

Modular Features

- Meter body replacement
- Add or remove standard displays
- Add or remove lightning protection (terminal connection)

With no performance effects, *Honeywell's unique modularity results in lower inventory needs and lower overall operating costs.*

Performance Specifications

Reference Accuracy: (conformance to +/-3 Sigma)

Model	URL	LRL	Min Span	Maximum Turndown Ratio	Stability (% URL/Year for five years)	Reference Accuracy % Span ^{1,2}
STA725	780 mmHgA (1040 mbarA)	0.0 mmHgA (0.0 mbarA)	50 mmHgA (65.0 mbarA)	15:1	0.025	0.065%
STA745	500 psia (35 barA)	0.0 mmHgA (0.0 mbarA)	5 psia (0.35 barA)	100:1		
STA72S	780 mmHgA (1040 mbarA)	0.0 mmHgA (0.0 mbarA)	50 mmHgA (65.0 mbarA)	15:1		
STA74S	500 psia (35 barA)	0.0 mmHgA (0.0 mbarA)	5 psia (0.35 barA)	100:1		
STA77S	3000 psi (210 barA)	0.0 mmHgA (0.0 mbarA)	30 psia (2.1 barA)	100:1		

Zero and span may be set anywhere within the listed (URL/LRL) range limits

Accuracy at Specified Span and Temperature: (Conformance to +/-3 Sigma)

		Accuracy ^{1,2} (% of Span)				Temperature Effect (% Span/50°F)	
Model	URL	Turn downs greater than	A	B	C (see URL units)	D	E
STA725	780 mmHgA (1040 mbarA)	7:1	0.015	0.05	120(160)	0.075	0.060
STA745	500 psia (35 barA)	17:1			30(2.07)	0.075	0.015
STA72S	780 mmHgA (1040 mbarA)	4:1			180(240)	0.075	0.120
STA74S	500 psia (35 barA)	17:1			30(2.07)	0.075	0.020
STA77S	3000 psi (210 barA)	5:1			600(41.37)	0.075	0.015
Turn Down Effect $\pm \left[A + B \left(\frac{C}{\text{Span}} \right) \right]$ % Span					Temp Effect $\pm \left[D + E \left(\frac{\text{URL}}{\text{Span}} \right) \right]$ % Span per 28°C (50°F)		

Total Performance (% of Span):

Total Performance Calculation: = +/- $\sqrt{(\text{Accuracy})^2 + (\text{Temperature Effect})^2}$

Total Performance Examples (for comparison): @ 5:1 Turndown, +/-50 °F (28°C) shift

STA725 @ 156 mmHgA: 0.381% of span

STA72S @ 156 mmHgA: 0.679% of span

STA745 @ 100 psia: 0.163% of span

STA74S @ 100 psia: 0.187% of span

STA77S @ 600 psia: 0.163% of span

Typical Calibration Frequency:

Calibration verification is recommended every two (2) years

Notes:

1. Terminal Based Accuracy - Includes combined effects of linearity, hysteresis, and repeatability. Analog output adds 0.006% of span.
2. For zero based spans and reference conditions of: 25°C (77°F), 10 to 55% RH, and 316 Stainless Steel barrier diaphragm.

Operating Conditions – All Models

Parameter	Reference Condition		Rated Condition		Operative Limits		Transportation and Storage	
	°C	°F	°C	°F	°C	°F	°C	°F
Ambient Temperature¹	25±1	77±2	-40 to 85	-40 to 185	-40 to 85	-40 to 185	-55 to 120	-67 to 248
Meter Body Temperature								
STA725 / STA72S	25±1	77±2	See Figure 2		See Figure 2		-55 to 125	-67 to 257
STA745, 74S, 77S	25±1	77±2	-40 to 110	-40 to 230	-40 to 125	-40 to 257	-55 to 125	-67 to 257
Humidity %RH	10 to 55		0 to 100		0 to 100		0 to 100	
Vacuum Region - Minimum Pressure STA725, 72S, 745, 74S, 77S	See Figure 2. Operate within specifications above 25 mmHgA (33 mbarA). Short term ² exposure to full vacuum will not result in damage.							
Supply Voltage, Current, and Load Resistance	10.8 to 42.4 Vdc at terminals (IS versions limited to 30 Vdc) 0 to 1,440 ohms (as shown in Figure 3)							
Maximum Allowable Working Pressure (MAWP)^{3, 4}	STA725, 72S = 780 mmHgA, 1,040 mbarA STA745, 74S = 500 psia, 35 barA STA77S = 3,000 psia, 210 barA							

¹ LCD Display operating temperature -20°C to +70°C Storage temperature -30°C to 80°C.

² Short term equals 2 hours at 70°C (158°F)

³ Units can withstand overpressure of 1.5 x MAWP without damage

⁴ Consult factory for MAWP of ST 700 transmitters with CRN approval

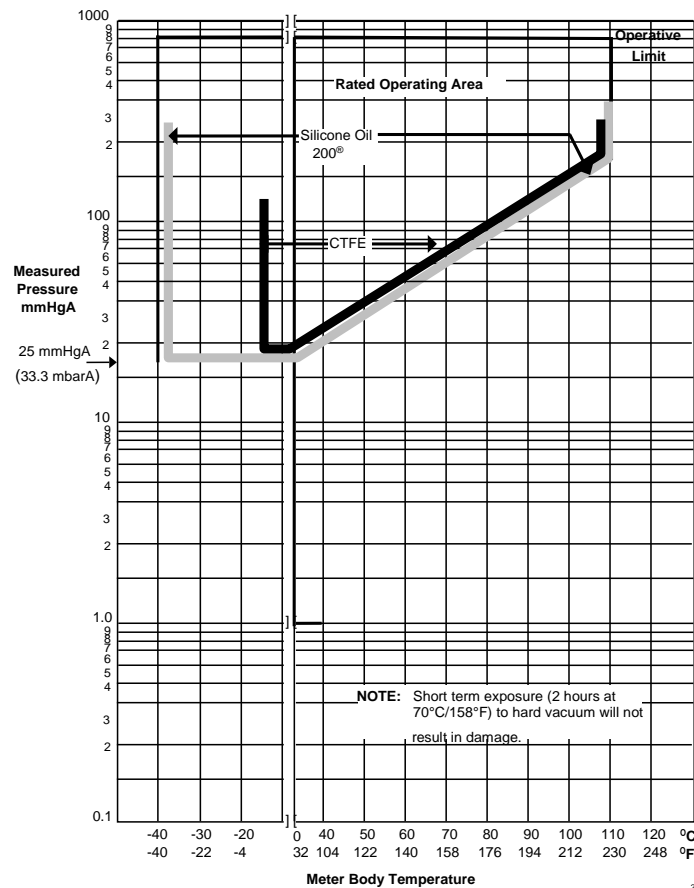

Figure 2 - Measured pressure versus meter body temperature chart for ST 700 Dual Head and Inline models

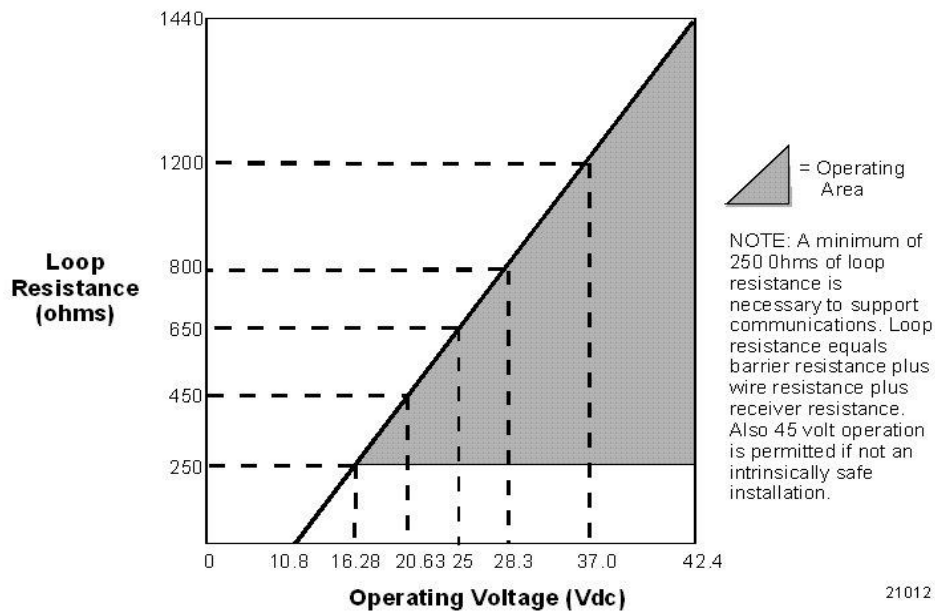

Figure 3 - Supply voltage and loop resistance chart & calculations

Performance Under Rated Conditions – All Models

Parameter	Description									
Analog Output	Two-wire, 4 to 20 mA									
Digital Communications:	HART 7 protocol									
HART Output Failure Modes	<table border="0"> <tr> <td></td> <td>Honeywell Standard:</td> <td>NAMUR NE 43 Compliance:</td> </tr> <tr> <td>Normal Limits:</td> <td>3.8 – 20.8 mA</td> <td>3.8 – 20.5 mA</td> </tr> <tr> <td>Failure Mode:</td> <td>≤ 3.6 mA and ≥ 21.0 mA</td> <td>≤ 3.6 mA and ≥ 21.0 mA</td> </tr> </table>		Honeywell Standard:	NAMUR NE 43 Compliance:	Normal Limits:	3.8 – 20.8 mA	3.8 – 20.5 mA	Failure Mode:	≤ 3.6 mA and ≥ 21.0 mA	≤ 3.6 mA and ≥ 21.0 mA
	Honeywell Standard:	NAMUR NE 43 Compliance:								
Normal Limits:	3.8 – 20.8 mA	3.8 – 20.5 mA								
Failure Mode:	≤ 3.6 mA and ≥ 21.0 mA	≤ 3.6 mA and ≥ 21.0 mA								
Supply Voltage Effect	0.005% of span per volt.									
Transmitter Turn on Time (includes power up & test algorithms)	2.5 sec									
Response Time (delay + time constant)	100ms									
Damping Time Constant	Adjustable from 0 to 32 seconds in 0.1 increments. Default Value: 0.5 seconds									
Vibration Effect	Less than +/- 0.1% of URL w/o damping Per IEC60770-1 field or pipeline, high vibration level (10-2000Hz: 0.21 displacement/3g max acceleration)									
Electromagnetic Compatibility	Meets IEC61326-3-1									
Lightning Protection Option	Leakage Current: 10uA max @ 42.4VDC 93C Impulse rating: <table border="0"> <tr> <td>8/20uS</td> <td>5000A (>10 strikes)</td> <td>10000A (1 strike min.)</td> </tr> <tr> <td>10/1000uS</td> <td>200A (> 300 strikes)</td> <td></td> </tr> </table>	8/20uS	5000A (>10 strikes)	10000A (1 strike min.)	10/1000uS	200A (> 300 strikes)				
8/20uS	5000A (>10 strikes)	10000A (1 strike min.)								
10/1000uS	200A (> 300 strikes)									

Materials Specifications (see model selection guide for availability/restrictions with various models)

Parameter	Description
Barrier Diaphragms Material	STA700 Dual Head: 316L SS, Hastelloy® C-276 ² STA700 Inline: 316L SS, Hastelloy C-276 ²
Process Head Material	STA700 Dual Head: Carbon Steel (Zinc Plated) ⁵ , 316 SS ⁴ , Hastelloy® C-276 ⁶ STA700 Inline: 316L SS ⁴ , Hastelloy® C-276 ⁶
Vent/Drain Valves & Plugs ¹	STA700 Dual Head: 316 SS ⁴ , Hastelloy® C-276 ² STA700 Inline: N/A
Head Gaskets	STA700 Dual Head: Glass-filled PTFE standard. Viton® and graphite are optional. STA700 Inline: N/A
Meter Body Bolting	STA700 Dual Head: Carbon Steel (Zinc plated) standard. Options include 316 SS, NACE A286 SS bolts and nuts or NACE A286 SS bolts nuts and Super Duplex STA700 Inline: N/A
Mounting Bracket	Carbon Steel (Zinc-plated) or 304 or 316 Stainless Steel. See Figures 4 & 5
Fill Fluid	Silicone 200, CTFE (Chlorotrifluoroethylene)
Electronic Housing	Pure Polyester Powder Coated Low Copper (<0.4%)-Aluminum. Meets NEMA 4X, IP66, IP67 and NEMA 7 (explosion proof). All stainless steel housing is optional.
Process Connections	STA700 Dual Head: ½ -inch NPT (female) STA700 Inline: ½ -inch NPT (female), ½ -inch NPT male, 9/16 Aminco. G½ -B Male Thread
Wiring	Accepts up to 16 AWG (1.5 mm diameter).
Dimensions	See Figure 4 and Figure 5
Net Weight	STA700 Dual Head: 8.3 pounds (3.8 Kg). STA700 InLine: 3.6 pounds (1.6 Kg) with Aluminum Housing

¹ Vent/Drains are sealed with Teflon®

² Hastelloy® C-276 or UNS N10276

⁴ Supplied as 316 SS or as Grade CF8M, the casting equivalent of 316 SS.

⁵ Carbon Steel heads are zinc-plated and not recommended for water service due to hydrogen migration. For that service, use 316 stainless steel wetted Process Heads.

⁶ Hastelloy® C-276 or UNS N10276. Supplied as indicated or as Grade CW12MW, the casting equivalent of Hastelloy® C-276

Communications Protocols & Diagnostics

HART Protocol

Version:

HART 7

Power Supply

Voltage: 10.8 to 42.4Vdc at terminals

Load: Maximum 1440 ohms See [Figure 3](#)

Minimum Load: 0 ohms. (For handheld communications a minimum load of 250 ohms is required)

Standard Diagnostics

ST 700 top level diagnostics are reported as either critical or non-critical and readable via the DD/DTM tools or integral display as shown below.

Critical Diagnostics

HART DD/DTM Tools	Standard Display
Electronic Module DAC Failure	Fault Comm EI
Meter Body NVM Corrupt	Fault Mtrbody
Config. Data Corrupt	Fault Comm EI
Electronic Module Diag Failure	Fault Comm EI
Meter Body Critical Failure	Fault Mtrbody
Sensor Comms Timeout	Fault Mbd Com

Non-Critical Diagnostics

HART DD/DTM Tools
Display Failure
Electronic Module Comm Failure
Meter Body Excess Correct
Sensor Over Temperature
Fixed Current Mode
PV Out of Range
No Factory Calibration
LRV Set Error – Zero Config. Button
URV Set Error – Zero Config. Button
AO Out of Range
Loop Current Noise
Meter Body Unreliable Comm
No DAC Calibration
Sensor Supply Voltage Low

Refer to ST 700 diagnostics tech note for additional level diagnostic information.

Approval Certifications:

AGENCY	TYPE OF PROTECTION	FIELD PARAMETERS	AMBIENT TEMP (Ta)
FM Approvals™	Explosionproof: Class I, Division 1, Groups A, B, C, D; Dust Ignition Proof: Class II, III, Division 1, Groups E, F, G; Class I, Zone 0/1, AEx d IIC Ga/Gb Class II, Zone 21, AEx tb IIIC Db T 95°C	Note 1	T5: -50 °C to 85°C T6: -50 °C to 65°C
	Intrinsically Safe: Class I, II, III, Division 1, Groups A, B, C, D, E, F, G Class I, Zone 0, AEx ia IIC Ga		T4: -50 °C to 70°C
	Nonincendive: Class I, Division 2, Groups A, B, C, D Class I, Zone 2, AEx nA IIC Gc	Note 1	T4: -50 °C to 85°C
	Enclosure: Type 4X/ IP66/ IP67	All	-
Canadian Standards Association (CSA)	Explosion Proof: Class I, Division 1, Groups A, B, C, D; Dust Ignition Proof: Class II, III, Division 1, Groups E, F, G; Ex d IIC Ga Ex tb IIIC Db T 95°C	Note 1	T5: -50 °C to 85°C T6: -50 °C to 65°C
	Intrinsically Safe: Class I, II, III, Division 1, Groups A, B, C, D, E, F, G Ex ia IIC Ga		T4: -50 °C to 70°C
	Nonincendive: Class I, Division 2, Groups A, B, C, D; T4 Ex nA IIC Gc T4	Note 1	T4: -50 °C to 85°C
	Enclosure: Type 4X/ IP66/ IP67	All	-
ATEX	Flameproof: II 1/2 G Ex d IIC Ga/Gb II 2 D Ex tb IIIC Db T 95°C	Note 1	T5: -50 °C to 85°C T6: -50 °C to 65°C
	Intrinsically Safe: II 1 G Ex ia IIC Ga		T4: -50 °C to 70°C
	Nonincendive: II 3 G Ex nA IIC Gc	Note 1	T4: -50 °C to 85°C
	Enclosure: IP66/ IP67	All	-

Approval Certifications: (Continued)

IECEX (World)	Flameproof : Ex d IIC Ga/Gb Ex tb IIIC Db T 95°C	Note 1	T5: -50 °C to 85°C T6: -50 °C to 65°C
	Intrinsically Safe: Ex ia IIC Ga		T4: -50 °C to 70°C
	Nonincendive: Ex nA IIC Gc	Note 1	T4: -50 °C to 85°C
	Enclosure: IP66/ IP67	All	-
NEPSI (China)	Flameproof: Ex d IIC Ga/Gb Ex tb IIIC Db T 85°C	Note 1	T5: -50 °C to 85°C T6: -50 °C to 65°C
	Intrinsically Safe: Ex ia IIC Ga		T4: -50 °C to 70°C
	Nonincendive: Ex nA IIC Gc	Note 1	T4: -50 °C to 85°C
	Enclosure : IP 66/67	All	-

Notes:

- Operating Parameters:
Voltage= 11 to 42 V DC Current= 4-20 mA Normal

Other Certification Options

Materials

- oNACE MRO175, MRO103, ISO15156

SIL 2/3 Certification	IEC 61508 SIL 2 for non-redundant use and SIL 3 for redundant use according to EXIDA and TÜV Nord Sys Tec GmbH & Co. KG under the following standards: IEC61508-1: 2010; IEC 61508-2: 2010; IEC61508-3: 2010.
------------------------------	---

Mounting Configurations (Inline Designs)

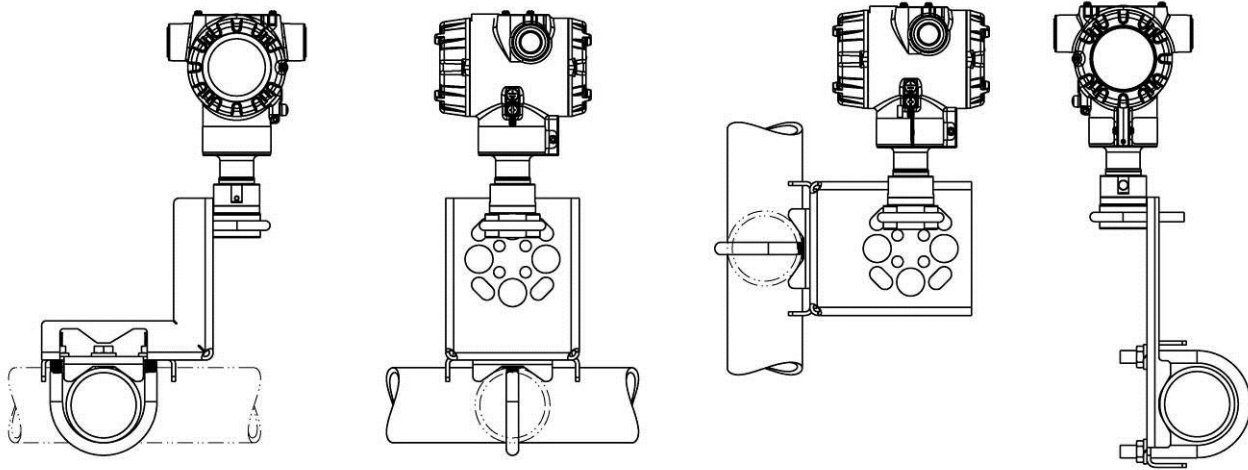

Dimension (Inline Design)

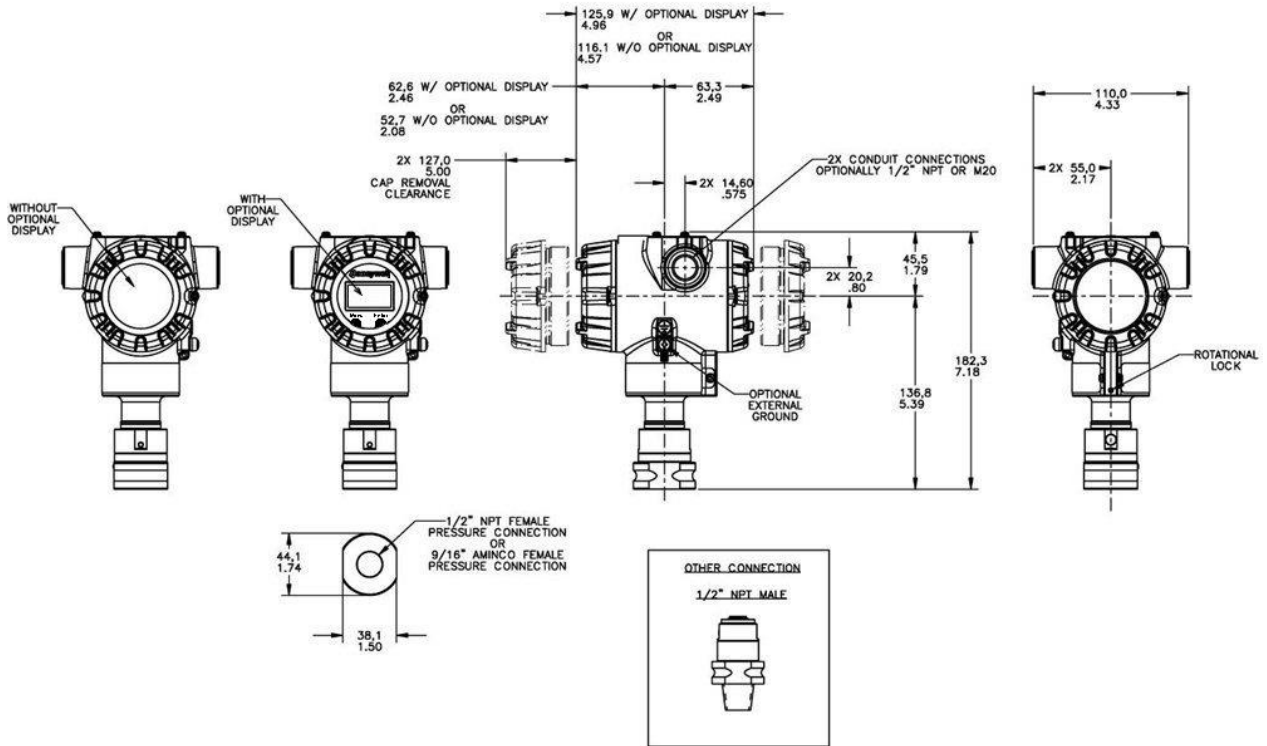

Figure 5 – Typical mounting dimensions of STA72S, STA74S, & STA77S for reference

Model Selection Guides are subject to change and are inserted into the specifications as guidance only. Prior to specifying or ordering a model check for the latest revision Model Selection Guides which are published at: www.honeywellprocess.com/en-US/pages/default.aspx

Model Selection Guide

**Model STA700
Absolute Pressure Transmitters**

Model Selection Guide
34-ST-16-120 Issue 1

Instructions: Make selections from all Tables using column below the proper arrow. Asterisk indicates availability. Letter (a) refers to restrictions highlighted in the restrictions table. Tables delimited with dashes.

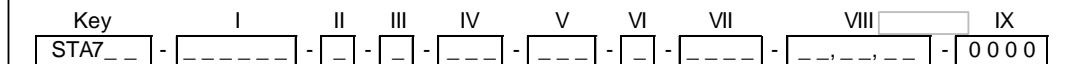

KEY NUMBER	URL/Max Span	LRL	Min Span	Units
Absolute Dual Head	780 (1040)	0 (0)	50 (65.0)	mm HgA (mbarA)
	500 (35)	0 (0)	5 (.35)	psia (barA)
Absolute In-Line	780 (1040)	0 (0)	50 (65.0)	mm HgA (mbarA)
	500 (35)	0 (0)	5 (.35)	psia (barA)
	3000 (210)	0 (0)	30 (2.1)	psia (barA)

Selection	
STA725	↓
STA745	↓
STA72S	↓
STA74S	↓
STA77S	↓

TABLE I		METER BODY SELECTIONS			
a. Process Head & Diaphragm Materials	Process Head/Reference Head Mat^{1b}		Barrier Diaphragm Material		
	Plated Carbon Steel /Plated Carbon Steel		316L SS Hastelloy [®] C - 276		
	316 Stainless Steel /316 Stainless Steel		316L SS Hastelloy C - 276		
	Hastelloy C - 276 /316 Stainless Steel		Hastelloy C - 276		
b. Fill Fluid	Silicone Oil 200 Fluorinated Oil CTFE				
c. Process Connection	Size/Type		Material		
	9/16" Aminco		Same as Process Head		
	1/2" NPT (female)		Same as Process Head ^{1a}		
	1/2" NPT (male)		Same as Process Head		
G 1/2 B Threaded Fitting		Same as Process Head			
d. Bolt/Nuts Materials	None				
	Carbon Steel				
	316 SS				
	Grade 660 (NACE A286) with NACE 304 SS Nuts				
	Grade 660 (NACE A286) Bolts & Nuts Super Duplex				
e. Vent/Drain Type/Location	Head Type	Vent Type	Vent Location	Vent Material	
	None	None	None	None	
	Single Ended	None	None	None	
	Single Ended	Std Vent	Side	Matches Head Material ¹	
	Single Ended	Center Vent	Side	Stainless Steel Only	
	Dual Ended	Std Vent	End	Matches Head Material ¹	
	Dual Ended	Center Vent	End	Stainless Steel Only	
	Dual Ended	Std Vent/ Plug	Side/End	Matches Head Material ¹	
f. Gasket Materials	None				
	Teflon [®] or PTFE (Glass Filled)				
	Viton [®]				
	Graphite				

A	*	
B	*	
E	*	*
F	*	*
J	*	*
_1	*	*
_2	*	*

_A	*	*
_G	*	*
_H	*	*
_B	*	*
_0	*	*
_C	*	*
_S	*	*
_N	*	*
_K	p	
_D	p	

_0	*	*
_1	*	*
_2	*	*
_3	t	
_4	*	*
_5	t	
_6	*	*
_0	*	*
_A	*	*
_B	*	*
_C	*	*

¹ Except Carbon Steel Heads shall use 316SS Vent/Drain & Plugs

^{1a} STA725,745 supplied via 1/2" flange adapter same material as process head except carbon steel shall use 316 SS

^{1b} Reference head available only with Dual head models. In-line models supplied with process head only

STANDARD	REVERSED	90°/STANDARD
SELECTION 1⁴	SELECTION 2	SELECTION 3

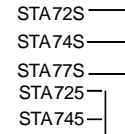
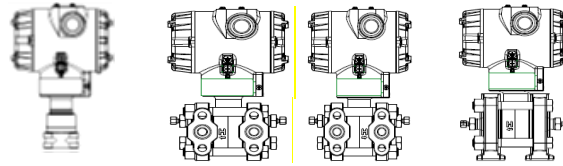

TABLE II Meter Body & Connection Orientation		
Head/Connect Orientation	Standard	High Side Left, Ref Side Right ² / Std Head Orientation
	Reversed	Ref Side Left, High Side Right ²
	90/Standard	High Side Left, Ref Side Right ² / 90° Head Rotation

1	*	*
2	*	
3	h	

TABLE III AGENCY APPROVALS	
Approvals	No Approvals Required
	<FM> Explosion proof, Intrinsically Safe, Non-incendive, & Dustproof
	CSA Explosion proof, Intrinsically Safe, Non-incendive, & Dustproof
	ATEX Explosion proof, Intrinsically Safe & Non-incendive
	IECEX Explosion proof, Intrinsically Safe & Non-incendive
	NEPSI Explosion proof, Intrinsically Safe & Non-incendive

0	*	*
A	*	*
B	*	*
C	*	*
D	*	*
G	*	*

TABLE IV TRANSMITTER ELECTRONICS SELECTIONS			
a. Electronic Housing Material & Connection Type	Material	Connection	Lightning Protection
	Polyester Powder Coated Aluminum	1/2 NPT	None
	Polyester Powder Coated Aluminum	M20	None
	Polyester Powder Coated Aluminum	1/2 NPT	Yes
	Polyester Powder Coated Aluminum	M20	Yes
	316 Stainless Steel (Grade CF8M)	1/2 NPT	None
	316 Stainless Steel (Grade CF8M)	M20	None
	316 Stainless Steel (Grade CF8M)	1/2 NPT	Yes
	316 Stainless Steel (Grade CF8M)	M20	Yes
b. Output/Protocol	Analog Output		Digital Protocol
	4-20mA dc		HART Protocol
c. Customer Interface Selections	Indicator	Ext Zero,Span & Config Buttons	Languages
	None	None	None
	None	Yes (Zero/Span Only)	None
	Standard(w/Internal Zero,Span&Config Buttons)	None	EN
	Standard(w/Internal Zero,Span&Config Buttons)	Yes	EN

A__	*	*
B__	*	*
C__	*	*
D__	*	*
E__	*	*
F__	*	*
G__	*	*
H__	*	*

H	*	*
-----	---	---

__0	*	*
__A	*	*
__S	*	*
__T	*	*

TABLE V CONFIGURATION SELECTIONS			
a. App S/W	Diagnostics		
	Standard Diagnostics		
b. Output Limit, Failsafe & Write Protect Settings	Write Protect	Fail Mode	High & Low Output Limits ³
	Disabled	High> 21.0mAdc	Honeywell Std (3.8 - 20.8 mAdc)
	Disabled	Low< 3.6mAdc	Honeywell Std (3.8 - 20.8 mAdc)
	Enabled	High> 21.0mAdc	Honeywell Std (3.8 - 20.8 mAdc)
	Enabled	Low< 3.6mAdc	Honeywell Std (3.8 - 20.8 mAdc)
c. General Configuration	General Configuration		
	Factory Standard Customer Configuration (Unit Data Required)		

1__	*	*
-----	---	---

1	*	*
2	*	*
3	*	*
4	*	*

__S	*	*
__C	*	*

² Left side/Right side as view ed from the customer connection perspective

³ NAMUR Output Limits 3.8 - 20.5mAdc can be configured by the custom

⁴ Process Connections will vary on In-Line models

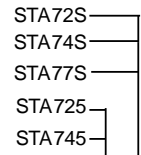

A	*	*
B	*	*

TABLE VI CALIBRATION & ACCURACY SELECTIONS			
a. Accuracy and Calibration	Accuracy	Calibrated Range	Calibration Qty
	Standard	Factory Std	Single Calibration
	Standard	Custom (Unit Data Required)	Single Calibration

TABLE VII ACCESSORY SELECTIONS		
a. Mounting Bracket	Bracket Type	Material
	None	None
	Angle Bracket	Carbon Steel
	Angle Bracket	304 SS
	Angle Bracket	316 SS
	Flat Bracket	Carbon Steel
	Flat Bracket	304 SS
	Flat Bracket	316 SS
b. Customer Tag	Customer Tag Type	
	No customer tag	
c. Unassembled Conduit Plugs & Adapters	Unassembled Conduit Plugs & Adapters	
	No Conduit Plugs or Adapters Required	
	1/2 NPT Male to 3/4 NPT Female 316 SS Certified Conduit Adapter	
	1/2 NPT 316 SS Certified Conduit Plug	
	M20 316 SS Certified Conduit Plug	

0 ___	*	*
1 ___	*	*
2 ___	*	*
3 ___	*	*
5 ___	*	*
6 ___	*	*
7 ___	*	*

_ 0 _ _	*	*
_ 1 _ _	*	*

_ _ A0	*	*
_ _ A2	n	n
_ _ A6	n	n
_ _ A7	m	m

TABLE VIII OTHER Certifications & Options: (String in sequence comma delimited (XX, XX, XX,...))	
Certifications & Warranty	None - No additional options
	NACE MR0175; MR0103; ISO15156 Process wetted parts only
	NACE MR0175; MR0103; ISO15156 Process wetted and non-wetted parts
	EN10204 Type 3.1 Material Traceability
	Certificate of Conformance
	Calibration Test Report & Certificate of Conformance
	Certificate of Origin
	FMEDA(SIL 2/3) Certification
	Over-Pressure Leak Test Certificate (1.5X MAWP)
	Cert Clean for O ₂ or CL ₂ service per ASTM G93
	PM Certification ⁵
	Extended Warranty Additional 1 year
	Extended Warranty Additional 2 years
	Extended Warranty Additional 3 years
	Extended Warranty Additional 4 years

00	*	*	
FG	*	*	b
F7	c	c	
FX	*	*	
F3	*	*	b
F1	*	*	
F5	*	*	
FE	j	j	
TP	*	*	
OX	e	e	
PM	*	*	
01	*	*	
02	*	*	b
03	*	*	
04	*	*	

TABLE IX Manufacturing Specials	
Factory	Factory Identification

0 0 0 0	*	*
---------	---	---

RESTRICTIONS

Restriction Letter	Available Only with		Not Available with	
	Table	Selection(s)	Table	Selection(s)
c	Id	___0,N,K,D__		
e	lb	_2_____		
h			le	___4,5,6_
			VIIa	1,2,3,5,6,7___
j			Vb	_1,2_
m	IV a	B,D,F,H__		
n	IV a	A,C,E,G__		
p			III	B - No CRN number available
t			1a	J_____
b	Select Only one option from this group			

⁵The PM option is available on all Smartline Pressure Transmitter process wetted parts such as process heads, flanges, bushings and vent plugs except plated carbon steel process heads and flanges. PM option information is also available on diaphragms except STG and STA in-line construction pressure transmitters.

FIELD INSTALLABLE ACCESSORY KITS

Description	Kit Number
Terminal Strip w/Lightning Protection Kit for HART Module	50129832-501
Terminal Strip w/o Lightning Protection for HART Module	50129832-502
HART Electronics Module	50129828-501
HART Electronics Module w/connection for external Zero/Span buttons	50129828-502
Standard Display Module	50126003-501

Sales and Service

For application assistance, current specifications, pricing, or name of the nearest Authorized Distributor, contact one of the offices below.

ASIA PACIFIC

Honeywell Process Solutions,
(TAC) hfs-tac-support@honeywell.com

Australia

Honeywell Limited
Phone: +(61) 7-3846 1255
FAX: +(61) 7-3840 6481
Toll Free 1300-36-39-36
Toll Free Fax:
1300-36-04-70

China – PRC - Shanghai

Honeywell China Inc.
Phone: (86-21) 5257-4568
Fax: (86-21) 6237-2826

Singapore

Honeywell Pte Ltd.
Phone: +(65) 6580 3278
Fax: +(65) 6445-3033

South Korea

Honeywell Korea Co Ltd
Phone: +(822) 799 6114
Fax: +(822) 792 9015

EMEA

Honeywell Process Solutions,
Phone: + 80012026455 or
+44 (0)1344 656000

Email: (Sales)

FP-Sales-Apps@Honeywell.com

or

(TAC)

hfs-tac-support@honeywell.com

AMERICA'S

Honeywell Process Solutions,
Phone: (TAC) 1-800-423-9883 or
215/641-3610
(Sales) 1-800-343-0228

Email: (Sales)

FP-Sales-Apps@Honeywell.com

or

(TAC)

hfs-tac-support@honeywell.com

Specifications are subject to change without notice.

For more information

To learn more about SmartLine Pressure Transmitters visit www.honeywellprocess.com
Or contact your Honeywell Account Manager

Process Solutions

Honeywell
1250 W Sam Houston Pkwy S
Houston, TX 77042

Honeywell Control Systems Ltd
Honeywell House, Skimped Hill Lane
Bracknell, England, RG12 1EB

Shanghai City Centre, 100 Jungi Road
Shanghai, China 20061

www.honeywellprocess.com



Honeywell

AUTHORIZED DISTRIBUTOR

De Gids & Feldman BV
The Netherlands
www.dgfg.nl



INSTRUMENTATION & FILTRATION

Honeywell

34-ST-03-120
November 2016

©2016 Honeywell International Inc.