

VersaFlow Vortex 100 Vortex Flow Meter Specifications

34-VF-03-05 May 2011



The All-In-One Solution

The VERSAFLOW is the only vortex flowmeter with integrated pressure and temperature compensation in 2-wire technology. The VERSAFLOW Vortex Flow Meter provides reliable measurement of operating, standard volumetric and mass flow of conductive and non-conductive liquids, gases and vapors, even with fluctuating pressures and temperatures.

Highlights

- 2-wire device with integrated pressure and temperature compensation
- Non-wearing, fully welded stainless steel construction with high corrosion, pressure and temperature resistance
- Optimal process reliability thanks to Intelligent Signal Processing (ISP) - stable readings, free of external perturbations
- Ready to use immediately thanks to plug & play
- Maintenance-free sensor design
- PACTware available at no extra cost
- Pressure and temperature can be called up via HART
- Optional Remote electronics for easier access to local programming and display

Industries

- Chemical
- Oil & Gas
- Power plants
- Iron, Steel and Metal
- Paper and Pulp
- Water
- Automotive



Figure 1 – VersaFlow Vortex Flow Meter

Applications

- Vapor and saturated steam measurement
- Steam boiler monitoring
- Monitoring of compressor output
- Measurement of consumption in compressed air systems
- Measurement of consumption of industrial gases
- SIP and CIP processes in the food, beverage and pharmaceutical industries
- Measurement of conductive and non-conductive liquids

Options and Variants

1. The universal device with temperature compensation for saturated steam integrated as standard



The VERSAFLOW as a compact flowmeter in a flange version is suitable for universal use in measuring liquids, gases and vapors.

The temperature compensation for saturated steam is integrated as standard, thus enabling direct compensation of the density; the mass and energy can also be measured.

Here ISP (Intelligent Signal Processing) provides stable measurement results free of external perturbations.

2. The easy to install sandwich version with optimised centering rings



The VERSAFLOW as a compact flowmeter in a sandwich version is suitable for universal use in the measurement of liquids, gases and vapors. The temperature compensation for saturated steam is integrated as standard.

The flowmeter is provided with additional optimised centering rings. The VERSAFLOW can be aligned centrally by turning the centering rings, eliminating any offset between the VERSAFLOW and the pipeline.

3. The only 2-wire device with integrated pressure and temperature compensation



The VERSAFLOW as a flange or sandwich flowmeter is optionally available with integrated pressure and temperature compensation for gases, wet gases, gas mixtures or vapors. The advantages of this unique design couldn't be clearer:

- No additional cost-intensive installation of pressure and temperature sensors
- No additional cabling work
- No faulty measurement results, because pressure, temperature and volume flow can be read at a single point
- Direct measurement of mass and/or energy

4. The highest process availability thanks to optional shut-off valve



As an option, HONEYWELL can supply the VERSAFLOW with a shut-off valve to allow the pressure sensor to be exchanged without interrupting the process. What is more, the pressure sensor can be shut off for the purpose of pressure or leak testing of the pipeline. Using the built-in two-way valve, the pressure sensor can also be calibrated and tested at a later time.

5. Dual measurement for twofold reliability



The VERSAFLOW is optionally available as a dual version.

This is a genuine redundant system with two independent sensors and two converters.

This provides twofold functional reliability and availability of the measurement.

This variant is optimally suited for measurements in multiproduct pipelines.

In such pipelines, two different products are moved through one after the other.

Here one converter can be programmed for one product, and the other converter for the other product.

6. Remote electronics option allows easier access to the local programming and display

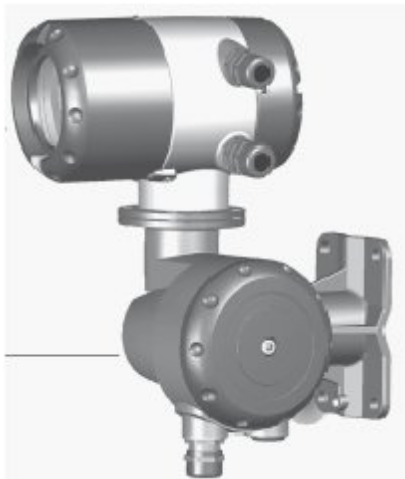

Both the sandwich and the flanged versions of the VersaFlow Vortex meter are available with compact or remote electronics. The option of remote electronics does not limit the choice of integral pressure sensing or the ability to select the dual measurement option.

The remote converter can be mounted up to 30m from the sensor.

PACTware Simple and Intuitive

PACTware diagnosis

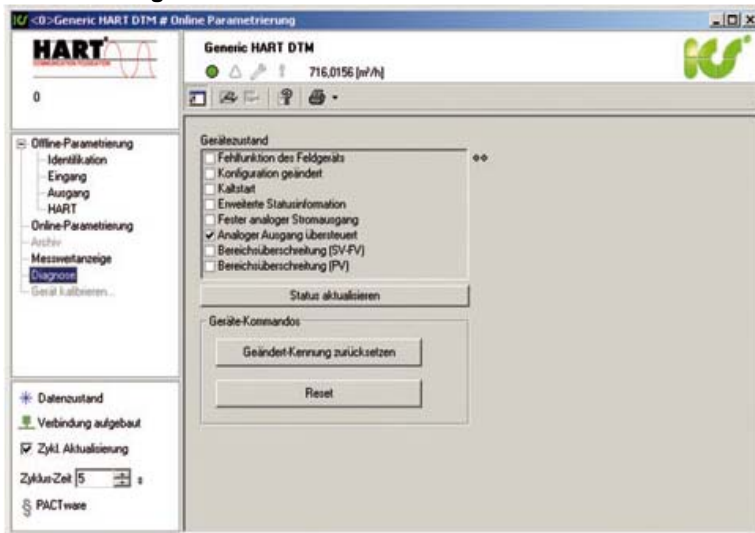

The VERSAFLOW is PACTware-ready. Each device is supplied ex factory with the appropriate DTM (Device Type Manager). A DTM is a device driver containing a user interface optimised for each device, and which makes the device functionality available independently of the field bus protocol.

A graphical user interface enables operation and configuration of the meter. Simple, program-based setup of devices is thus possible from the control room, even without a display or keyboard. The best possible operator control concepts have been implemented, optimised for the user's requirements.

PACTware reading display

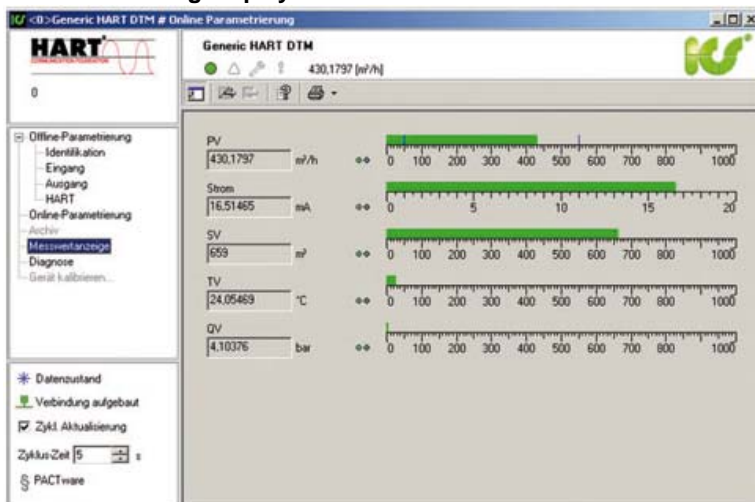

Features:

- Displays measured values
- Records measured information during operation
- Shows status of device
- Stepwise setup
- Displays summary of setup selection for final checking

PACTware online parameter configuration

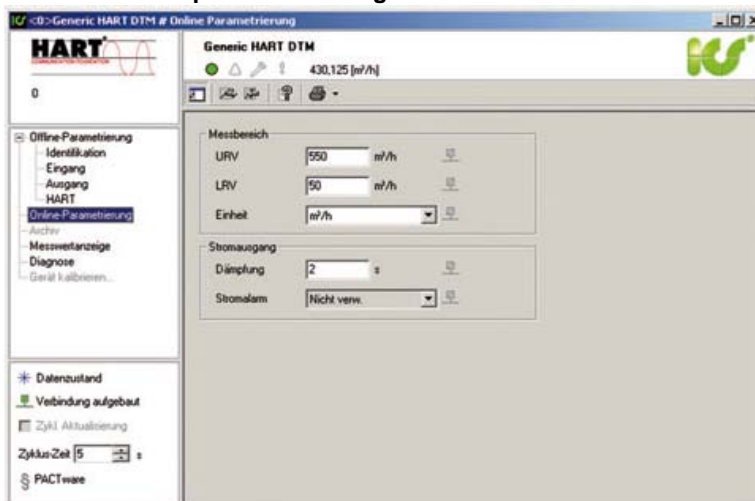

Technical Data

Measuring System

Application range	Flow measurement of liquids, gases and vapors
Operating method / measuring principle	Karman vortex street
Measured value	
Primary measured value:	Number of separated vortices
Secondary measured value:	Operating and standard volumetric flow, mass flow
Signal Converter	
Versions	- Compact (Option: Ex version) - Remote to 30m (Option: EX version)
Measuring Sensor	
Standard	Basic device in flange version (with integrated temperature measurement)
	Basic device in sandwich version (with integrated temperature measurement)
Optional	Basic device with additional pressure measurement
	Basic device with additional pressure measurement and shut-off valve for pressure sensor
	Dual measuring device in both flange and sandwich version (redundant measurement)
	Dual measuring device in sandwich with additional pressure measurement
Display and user interface	
Local display	2 lines, 10 characters per line
Operating and display languages	German, English, French

Measuring Accuracy

Reference condition	Water at 20°C
	Air at 20°C and 1.013 bar abs.
Accuracy	Based on volume
Liquids	± 0.75% of measured value ($Re \geq 20000$)
	± 2% of measured value ($10000 < Re < 20000$)
Gases and steams	±1.0% of measured value ($< Re < 20000$)
	±2.0% of measured value ($10000 < Re < 20000$)
	Pressure temperature compensation ±1.5% of measured value ($Re \geq 20000$); ±2.5% of measured value ($10000 < Re < 20000$)
Repeatability	±0.1% of measured value
Long-term Stability	± 0.01% of measured value

Operating Conditions

Temperature	
Product	-40...+240°C / -40...+465°F
Ambient	Non Ex : -40...+85°C / -40...+185°F
	Ex: -40...+60°C / -40...+140°F
Pressure	
Product	Max. 100 bar / 1450psi; information on higher pressures on request.
Ambient	Atmosphere
Chemical properties	
Density	Taken into consideration when sizing
Viscosity	< 10 cP
Reynolds' number	10000...2300000
Recommended flow velocities	
Liquids	0.3...7m/s / 0.98...23ft/s (optional up to 10m/s / 32.8ft/s taking cavitation into account)
Gases and steams	2.0...80 m/s / 6.6...262.5 ft/s
	DN15: 3.0...45m/s / 9.8...148ft/s; DN25: 2.0...70m/s /
	For detailed information, see chapter "Flow tables"
Other conditions	
Protection category	IP 66/67

Installation Conditions

Inlet run	≥ 20 x DN (without disturbing flow, after pipe narrowing, after a single 90° bend)
	≥ 30 x DN (after a double bend 2x90°)
	≥ 40 x DN (after a double three-dimensional bend 2x90°)
	≥ 50 x DN (after control valves)
	≥ 2 DN before flow straightener; ≥ 8 DN after flow straightener (specified values apply only to original ≥ 20 DN inlet run)
Outlet run:	≥ 5 x DN
Dimensions and weights	For detailed information refer to chapter "Dimensions and weights".

Materials

Measuring sensor and process connections	Standard 1.4404/316 L. Option: Hastelloy C-22 on request.
Converter housing	Die-cast Aluminium
Pressure sensor gasket	Standard: FPM
	Option: FFKM
Measuring tube gasket	Standard 1.4435/316L
	Option: Hastelloy® C-276
	Selection depends on measuring sensor material/medium.

Process connections

Flange version	
DIN EN 1092-1	DN15...300 in PN16...100
ASME B16.5	½...12" in 150...600lbs
JIS B 2220	DN15...300 in JIS 10...20K
	For detailed information on combination flange/pressure rating, refer to chapter "Dimensions and weights".
Sandwich version	
DIN	DN15...100 in PN100 (higher pressures on request)
ASME	½...4" in 600lbs (higher pressures on request)
JIS	DN15...100 in 10...20K (higher pressures on request)

Electrical connections

Power supply	Non-Ex: 14 VDC...36 VDC Ex: 14 VDC...30 VDC
Current Output	
Description of the used abbreviations	U_{ext} = external voltage; R_L = load + resistance
Measuring range	4...20 mA (max. 20.8 mA) + HART® protocol
Over Range	20.8 mA +/- 1 % (105 % +/- 1%)
Load	Minimum 0 Ω ; maximum $RL = ((U_{ext} - 14 \text{ VDC}) / 22 \text{ mA})$
Error signal	Acc. To NAMUR NE43 Upper value $\geq 21.0 \text{ mA}$ Lower value $\leq 3.6 \text{ mA}$ (not with HART® protocol)
Pulse output	
Pulse rate	Non-Ex: 24 VDC as NAMUR or open < 1 mA, maximum 36 V closed 100 mA, $U < 2 \text{ V}$
Power supply	Ex: 24 VDC as NAMUR, or open < 1 mA, maximum 30 V, closed 100 mA, $U < 2 \text{ V}$
HART	
	HART® protocol via current output
Device revision	1
Physical Layer	FSK
Device category	Transmitter, galvanically isolated
System requirements	Load min. 250 Ω
Multidrop operation	4 mA

Approvals and certifications

ATEX	EEX Zone 1 – Ex II 2G EEx d ia [ia] IIC T6
	EEX Zone 2 – Ex II 3G EEx nA T4
IECEX	Ex d ia [ia] IIC T6 Gb
FM	Class I, Div. 1 +FMc
NEPSI	Ex d ia [ia] IIC T6 Gb

Flow Table

Measuring Range Limits

Size		Qmin	Qmax	Qmin	Qmax
DN to EN 1092-1	DN to ASME B16.5	EN 1092-1 [m3/h]	EN 1092-1 [m3/h]	ASME B16.5[m3/h]	ASME B16.5[m3/h]

Water

15	1/2	0.45	5.07	0.44	4.94
25	1	0.81	11.40	0.81	11.40
40	1 1/2	2.04	28.58	2.04	28.58
50	2	3.53	49.48	3.53	49.48
80	3	7.74	108.37	7.74	108.37
100	4	13.30	186.22	13.30	186.21
150	6	30.13	421.86	30.13	421.86
200	8	52.66	737.18	52.66	737.18
250	10	81.43	1140.02	81.43	1140.02
300	12	114.83	1607.61	114.83	1607.61
Values based on water at 20°C					

Air

15	1/2	6.72	57.91	6.72	56.46
25	1	10.20	130.29	10.20	130.29
40	1 1/2	25.35	326.63	25.35	326.63
50	2	43.89	565.49	43.89	565.49
80	3	96.14	1238.64	96.14	1238.60
100	4	165.14	2128.27	165.19	2128.27
150	6	374.23	4821.60	374.23	4821.60
200	8	653.95	8425.53	633.95	8425.50
250	10	977.16	13028.81	977.16	13028.14
300	12	1377.95	18372.66	1377.95	18372.66
Values based on air at 20°C and 1.013 bar abs					

Flow rate limits

Product	Nominal diameters		Minimum flow rates	Maximum flow rates
	to EN	to ASME	[m/s]	[m/s]
Liquids	DN15...DN300	DN 1/2"...DN12"	$0.5 \times (998 / \rho)^{0.5 \ 1}$	$7 \times (998 / \rho)^{0.47 \ 1}$
Gas, vapor	DN15...DN300	DN 1/2"...DN12"	$6 \times (1.29 / \rho)^{0.5 \ 2}$	$7 \times (998 / \rho)^{0.47 \ 2}$

¹ Minimum flow rates 0.4m/s - maximum flow rates 10m/s

² Minimum flow rates 2m/s - maximum flow rates 80m/s

ρ = Operating density [kg/m³]

Measuring Range Saturated Steam: 1-7 bar

Pressure: bar		1		3.5		5.2		7	
Density: kg/m ³		1.1350		2.4258		3.2765		4.1673	
Temperature: °C		121		148		160		171	
Flow: kg/hr		min	max	min	max	min	max	min	max
DN to EN 1092-1	DN to ASME B16.5								
15	0.5	5.9	37.0	7.5	76.1	8.7	104.1	9.8	132.4
25	1	11.8	129.4	17.3	276.5	20.1	373.5	22.7	475.1
40	1.5	29.6	370.7	43.4	792.3	50.4	1070.2	56.8	1361.2
50	2	51.3	641.8	75.0	1371.7	87.2	1852.8	98.3	2356.6
80	3	112.4	1405.8	164.3	3004.7	191.0	4058.4	215.4	5161.8
100	4	193.1	2415.5	282.4	5162.8	328.2	6973.3	370.1	8869.2
150	6	439.6	5472.4	639.7	11695.8	743.5	15798.0	838.4	20093.0
200	8	821.9	10279.0	1201.6	21969.7	1396.5	29675.0	1574.7	37743.0
250	10	1313.9	16433.0	1920.9	35121.4	2232.5	47439.0	2517.7	60337.0
300	12	1908.3	23866.0	2789.8	51010.7	3242.4	68899.0	3656.6	87630.0

Measuring Range Saturated Steam: 10.5 - 20 bar

Pressure: bar		10.5		14		17.5		20	
Density: kg/m ³		5.8880		7.6030		9.3170		10.5442	
Temperature: °C		186		199		209		215	
Flow: kg/h		min	max	min	max	min	max	min	max
DN to EN 1092-1	DN to ASME B16.5								
15	0.5	12.5	187.0	16.1	241.5	19.7	295.9	22.3	334.9
25	1	26.9	671.3	30.6	857.9	33.9	955.5	36.0	1020.2
40	1.5	67.5	1878.2	76.7	2150.7	84.9	2395.3	90.4	2557.7
50	2	116.9	3251.7	132.8	3723.4	147.0	4147.0	156.4	4428.1
80	3	256.0	7122.4	290.9	8155.8	322.1	9083.7	342.6	9699.3
100	4	439.9	12238.0	499.9	14013.0	553.4	15068.0	588.7	16666.0
150	6	996.6	27725.0	1132.5	31747.0	1253.7	35359.0	1333.7	37756.0
200	8	1872.1	52079.0	2127.3	59634.0	2354.9	66419.0	2505.2	70921.0
250	10	2992.7	83254.0	3400.7	95333.0	3764.6	106180.0	4004.9	113380.0
300	12	4346.5	120920.0	4939.1	138460.0	5467.5	154210.0	5816.5	164660.0

Measuring Range Saturated Steam: 15 - 102 psig

Pressure: psig		15		51		75		102	
Density: lb/ft ³		0.0709		0.1516		0.2047		0.2604	
Temperature: °F		249		148		160		171	
Flow: lb/hr		min	max	min	max	min	max	min	max
DN to EN 1092-1	DN to ASME B16.5								
15	0.5	12.9	81.4	16.5	167.7	19.2	229.3	21.6	291.6
25	1	26.0	285.0	38.1	609.1	44.3	822.8	49.9	1046.4
40	1.5	65.3	816.6	95.5	1745.2	110.9	2357.3	125.1	2998.2
50	2	113.0	1413.7	165.3	3021.5	192.0	4081.1	216.6	5190.7
80	3	247.6	3096.5	362.0	6618.3	420.7	8939.2	474.4	11369.6
100	4	425.4	5320.6	622.0	11372.0	722.8	15359.7	815.2	19535.7
150	6	968.2	12053.9	1409.0	25762.0	1637.6	34797.3	1846.8	44257.7
200	8	1810.4	22641.3	2646.7	48392.0	3076.0	65363.4	3468.5	83134.3
250	10	2894.1	36196.5	4231.1	77361.0	4917.4	104491.1	5545.6	132900.8
300	12	4203.3	52569.0	6145.0	112360.0	7141.8	151759.8	8054.2	193017.4

Measuring Range Saturated Steam: 152 - 290 psig

Pressure: psig		152		203		254		290	
Density: lb/ft ³		0.3679		0.4750		0.5821		0.6587	
Temperature: °F		367		389		408		419	
Flow: lb/hr		min	max	min	max	min	max	min	max
DN to EN 1092-1	DN to ASME B16.5								
15	0.5	27.5	411.9	35.5	531.9	43.5	651.8	49.2	737.7
25	1	59.3	1478.5	67.4	1889.6	74.6	2104.6	79.4	2247.1
40	1.5	148.7	4137.1	169.0	4737.3	187.1	5276.0	199.0	5633.7
50	2	257.5	7162.4	292.6	8201.4	323.9	9134.4	344.5	9753.5
80	3	563.9	15688.3	640.8	17964.6	709.4	20008.1	754.7	21364.1
100	4	969.0	26956.3	1101.1	30866.1	1218.9	33189.4	1296.7	36709.2
150	6	2195.2	61069.1	2494.5	69928.3	2761.5	77883.2	2937.7	83162.9
200	8	4123.6	114713.0	4685.7	131354.2	5187.0	146297.2	5518.1	156213.5
250	10	6591.8	183381.4	7490.5	209987.4	8292.1	233876.4	8821.4	249735.4
300	12	9573.8	266347.3	10879.1	304982.1	12042.9	339669.3	12811.7	362686.9

Dimensions and Weights (metric)

Flange version EN 1092-1

Size	Pressure rating	Dimensions [mm]					Weight [kg]	
		DN	PN	d	D	L	H	I
15	40	17.3	95	200	265	144	6.1	5.5
15	100	17.3	105	200	265	144	7.1	6.5
25	40	28.5	115	200	265	144	7.9	7.3
25	100	28.5	140	200	265	144	9.9	9.3
40	40	43.1	150	200	270	144	10.8	10.2
40	100	42.5	170	200	270	144	14.8	14.2
50	16	54.5	165	200	275	144	12.7	12.1
50	40	54.5	165	200	275	144	12.9	12.3
50	63	54.5	180	200	275	144	16.9	16.3
50	100	53.9	195	200	275	144	18.4	17.8
80	16	82.5	200	200	290	154	17.4	16.8
80	40	82.5	200	200	290	154	19.4	18.8
80	63	81.7	215	200	290	154	23.4	22.8
80	100	80.9	230	200	290	154	27.4	26.8
100	16	107.1	220	250	310	164	22	21.4
100	40	107.1	235	250	310	164	25	24.4
100	63	106.3	250	250	310	164	30	29.4
100	100	104.3	265	250	310	164	36	35.4
150	16	159.3	285	300	325	174	35.8	35.2
150	40	159.3	300	300	325	174	41.8	41.2
150	63	157.1	345	300	325	174	59.8	59.2
150	100	154.1	355	300	325	174	67.8	67.2
200	10	206.5	340	300	350	194	38.4	37.8
200	16	206.5	340	300	350	194	38.4	37.8
200	25	206.5	360	300	350	194	47.4	46.8
200	40	206.5	375	300	350	194	55.4	54.8
250	10	260.4	395	380	370	224	58.0	57.4
250	16	260.4	405	380	370	224	59.0	58.4
250	25	258.8	425	380	370	224	75.0	74.4
250	40	258.8	450	380	370	224	93.0	92.4
300	10	309.7	445	450	395	244	76.3	75.7
300	16	309.7	460	450	395	244	82.8	82.2
300	25	307.9	485	450	395	244	99.3	98.7
300	40	307.9	515	450	395	244	128.1	127.5

Side view

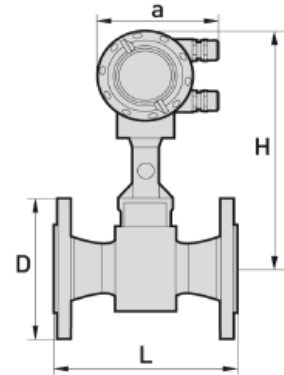

a = 133 mm / 5.24 inches

Front view

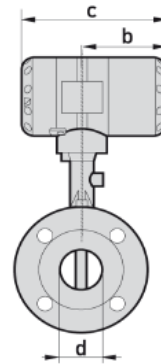

b = 105 mm / 4.13 inches
c = 179 mm / 7.05 inches

Option:
Version with two transmitters

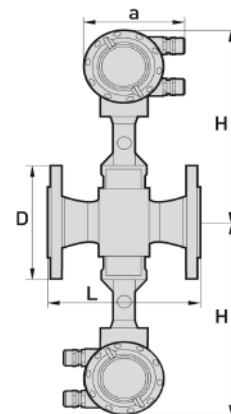

Specified weight + 2.80 kg

Flange Version ASME B16.5

Size	Pressure rating	Dimensions [mm]					Weight [kg]	
		DN	PN	d	D	L	H	I
1/2	150	15.8	90	200	265	144	5.1	4.5
1/2	300	15.8	95	200	265	144	5.5	4.9
1/2	600	13.9	95	200	265	144	5.7	5.1
1	150	26.6	110	200	265	144	6.8	6.2
1	300	26.6	125	200	265	144	7.8	7.2
1	600	24.3	125	200	265	144	8.1	7.5
1 1/2	150	40.9	125	200	270	144	8.9	8.3
1 1/2	300	40.9	155	200	270	144	11	10.4
1 1/2	600	38.1	155	200	270	144	12	11.4
2	150	52.6	150	200	275	144	11.6	11
2	300	52.6	165	200	275	144	13	12.4
2	600	49.3	165	200	275	144	14.5	13.9
3	150	78	190	200	290	154	20.4	19.8
3	300	78	210	200	290	154	23.4	22.8
3	600	73.7	210	200	290	154	24.4	23.8
4	150	102.4	230	250	310	164	24	23.4
4	300	102.4	255	250	310	164	32	31.4
4	600	97.2	275	250	310	164	41	40.4
6	150	154.2	280	300	325	174	36.8	36.2
6	300	154.2	320	300	325	174	51.8	51.2
6	600	146.3	355	300	325	174	76.8	46.2
8	150	202.7	345	300	350	194	50.6	50.0
8	300	202.7	380	300	350	194	75.4	74.8
10	150	254.5	405	380	370	224	75.0	74.4
10	300	254.5	455	380	370	224	107.0	106.4
12	150	304.8	485	450	395	244	106.9	106.3
12	300	304.8	520	450	395	244	151.9	151.3

Side view

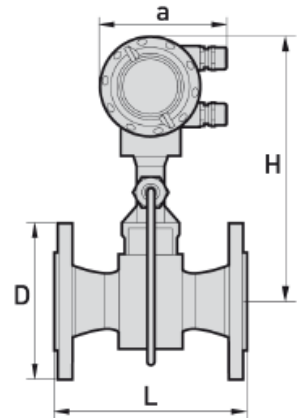

a = 133 mm / 5.24 inches

Front view

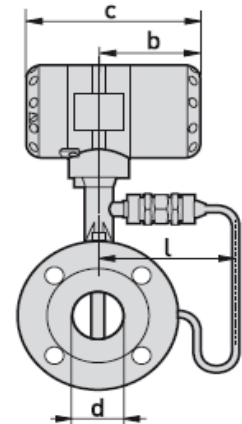

b = 105 mm / 4.13 inches

c = 179 mm / 7.05 inches

Dimensions and Weights (Imperial)

Flange Version ASME B16.5

Size	Pressure rating	Dimensions [inches]					Weight [lb]	
		DN	PN	d	D	L	H	I
1/2	150	0.62	3.54	7.87	10.43	5.67	11.24	9.92
1/2	300	0.62	3.74	7.87	10.43	5.67	12.13	10.8
1/2	600	0.54	3.74	7.87	10.43	5.67	12.57	11.24
1	150	1.05	4.33	7.87	10.43	5.67	14.99	13.67
1	300	1.05	4.92	7.87	10.43	5.67	17.2	15.87
1	600	0.96	4.92	7.87	10.43	5.67	17.86	16.53
1 1/2	150	1.61	4.92	7.87	10.63	5.67	19.62	18.3
1 1/2	300	1.61	6.1	7.87	10.63	5.67	24.25	22.93
1 1/2	600	1.5	6.1	7.87	10.63	5.67	26.46	25.13
2	150	2.07	5.91	7.87	10.83	5.67	25.57	24.25
2	300	2.07	6.5	7.87	10.83	5.67	28.66	27.34
2	600	1.94	6.5	7.87	10.83	5.67	31.97	30.64
3	150	3.07	7.48	7.87	11.42	6.06	44.97	43.65
3	300	3.07	8.27	7.87	11.42	6.06	51.59	50.26
3	600	2.9	8.27	7.87	11.42	6.06	52.79	52.47
4	150	4.03	9.06	9.84	12.21	6.46	52.91	51.59
4	300	4.03	10.04	9.84	12.21	6.46	70.55	69.22
4	600	3.83	10.83	9.84	12.21	6.46	90.39	89.07
6	150	6.07	11.02	11.81	12.8	6.85	81.13	79.81
6	300	6.07	12.6	11.81	12.8	6.85	114.2	112.88
6	600	5.76	13.98	11.81	12.8	6.85	169.31	101.85
8	150	7.98	13.58	11.81	13.78	7.64	146.39	145.65
8	300	7.98	14.96	11.81	13.78	7.64	190.32	189.65
8	600	7.63	16.54	11.81	13.78	7.64	331.57	330.25
10	150	10.02	15.51	14.96	14.57	8.82	197.09	195.77
10	300	10.02	17.91	14.96	14.57	8.82	252.21	239.86
10	600	9.56	20.08	14.96	14.57	8.82	419.76	418.43
12	150	12	19.09	17.72	15.55	9.61	318.34	317.02
12	300	12	20.47	17.72	15.55	9.61	415.35	414.02
12	600	11.37	22.05	17.72	15.55	9.61	543.21	541.89

Side view

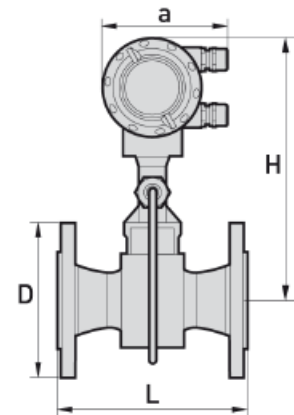

a = 133 mm / 5.24 inches

Front view

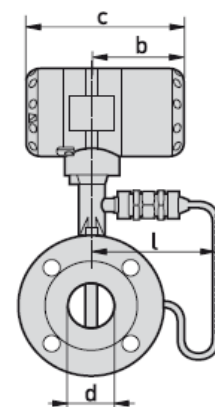

b = 105 mm / 4.13 inches

c = 179 mm / 7.05 inches

Dimensions and Weights (metric)

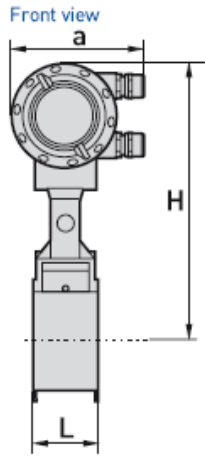

a = 133 mm / 5.24 inches

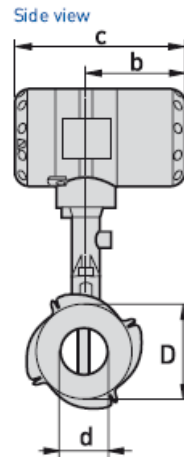

b = 105 mm / 4.13 inches
c = 179 mm / 7.05 inches

Sandwich Version EN

Size	Pressure rating	Dimensions [mm]					Weight [kg]	
		DN	PN	d	D	L	H	I
15	100	16	45	65	265	144	4.1	3.5
25	100	24	65	65	265	144	4.9	4.3
40	100	38	82	65	270	144	5.5	4.9
50	100	50	102	65	275	144	6.6	6
80	100	74	135	65	290	155	8.8	8.2
100	100	97	158	65	310	164	10.1	9.5

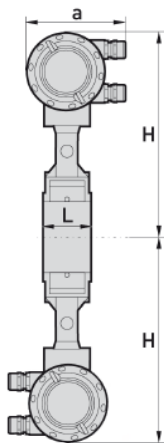

Specified weight + 2.80 kg

Option: Version with two transmitters

Dimensions and Weights (Imperial)

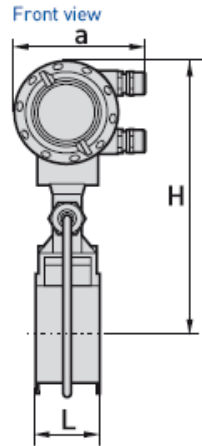

a = 133 mm / 5.24 inches

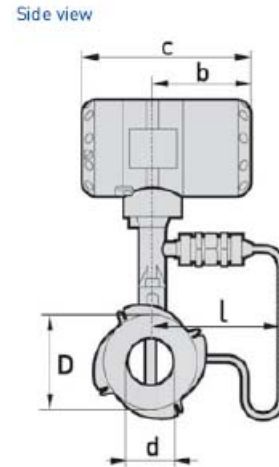

b = 105 mm / 4.13 inches
c = 179 mm / 7.05 inches

Sandwich Version ASME

Size	Pressure rating	Dimensions [inches]					Weight [lb]	
		DN	PN	d	D	L	H	I
1/2	150	0.63	1.77	2.56	10.43	5.67	9.04	7.72
1/2	300	0.63	1.77	2.56	10.43	5.67	9.04	7.72
1/2	600	0.55	1.77	2.56	10.43	5.67	9.04	7.72
1	150	0.94	2.56	2.56	10.43	5.67	10.8	9.48
1	300	0.94	2.56	2.56	10.43	5.67	10.8	9.48
1	600	0.94	2.56	2.56	10.43	5.67	10.8	9.48
1 1/2	150	1.5	3.23	2.56	10.63	5.67	12.13	10.8
1 1/2	300	1.5	3.23	2.56	10.63	5.67	12.13	10.8
1 1/2	600	1.5	3.23	2.56	10.63	5.67	12.13	10.8
2	150	1.97	4.02	2.56	10.83	5.67	14.55	13.23
2	300	1.97	4.02	2.56	10.83	5.67	14.55	13.23
2	600	1.97	4.02	2.56	10.83	5.67	14.55	13.23
3	150	2.91	5.31	2.56	11.42	6.1	19.4	18.08
3	300	2.91	5.31	2.56	11.42	6.1	19.4	18.08
3	600	2.91	5.31	2.56	11.42	6.1	19.4	18.08
4	150	3.82	6.22	2.56	12.21	6.46	22.27	20.94
4	300	3.82	6.22	2.56	12.21	6.46	22.27	20.94
4	600	3.82	6.22	2.56	12.21	6.46	22.27	20.94

Dimensions Remote version

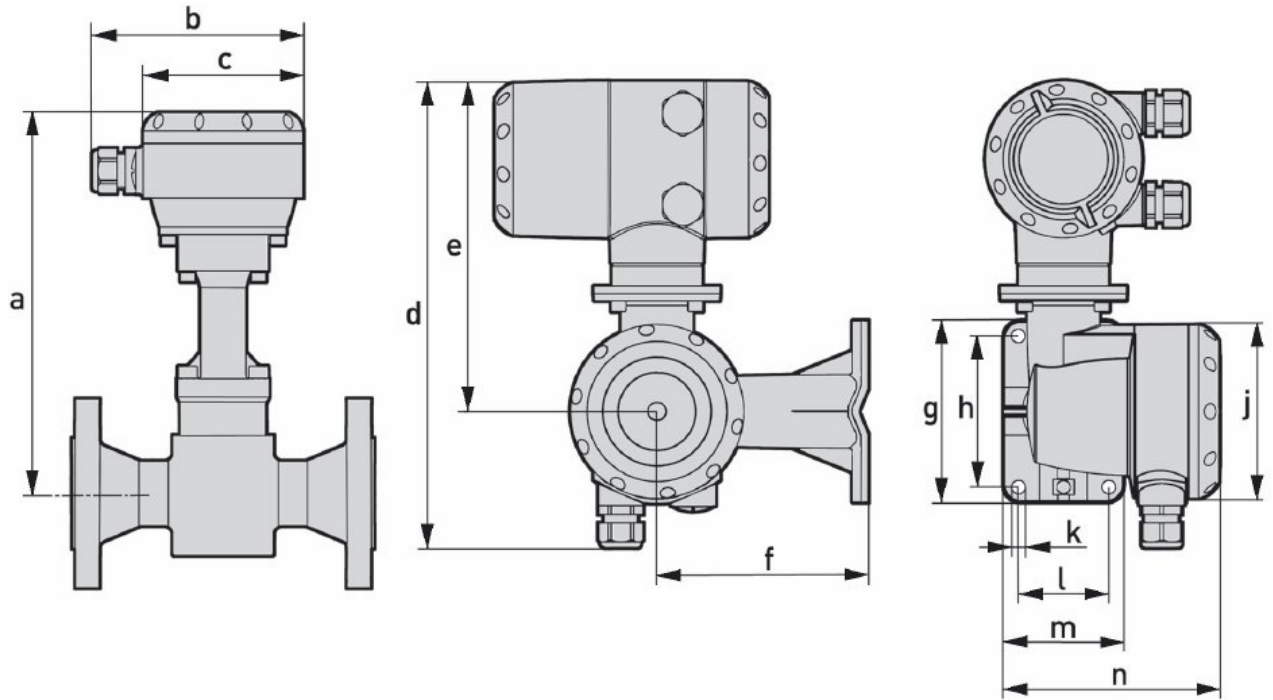

Dimension a

	Flanged version									
	Sandwich version									
DN	15	25	40	50	80	100	150	200	250	300
NPS	½	1	1 ½	2	3	4	6	8	10	12
[mm]	248	248	253	258	273	293	308	333	353	378
[“]	9.77	9.77	9.97	10.2	10.8	11.5	12.1	13.1	13.9	14.9

	b	c	d	e	f	g	h	j	k	l	m	n
[mm]	140	Ø106	310	219	140	120	100	Ø115	Ø9 (4x)	60	80	114
[“]	5.52	Ø4.18	12.2	8.63	5.52	4.73	3.94	Ø4.53	Ø0.36 (4x)	2.36	3.15	5.67

Specifications are subject to change without notice



Honeywell
AUTHORIZED DISTRIBUTOR

De Gidts & Feldman BV
The Netherlands
www.dgfg.nl



De Gidts & Feldman
INSTRUMENTATION & FILTRATION

For More Information

Learn more about how Honeywell's VersaFlow Vortex 100 Vortex Flow Meter can provide integrated pressure and temperature compensation in 2-wire technology, visit our website www.honeywell.com/ps/hfs or contact your Honeywell account manager.

Honeywell Process Solutions

1860 West Rose Garden Lane
Phoenix, Arizona 85027
Tel: 1-800-423-9883 or 1-800-343-0228
www.honeywell.com/ps/hfs

34-VF-03-05
May 2011
© 2011 Honeywell International Inc.

Honeywell