

Honeywell

Honeywell Process Solutions

Experion LX
Control Hardware Planning
Guide

EXDOC-XX23-en-110A

R110

February 2014

Release 110

Honeywell

Notices and Trademarks

**Copyright 2014 by Honeywell International Srl.
Release 110 February 2014**

While this information is presented in good faith and believed to be accurate, Honeywell disclaims the implied warranties of merchantability and fitness for a particular purpose and makes no express warranties except as may be stated in its written agreement with and for its customers.

In no event is Honeywell liable to anyone for any indirect, special or consequential damages. The information and specifications in this document are subject to change without notice.

Honeywell, PlantScape, Experion[®] LX, and **TotalPlant** are registered trademarks of Honeywell International Inc.

Other brand or product names are trademarks of their respective owners.

Honeywell Process Solutions
1860 W. Rose Garden Lane
Phoenix, AZ 85027 USA
1-800 822-7673

About This Document

This document provides an overview of things you should consider when planning for the installation of your Experion LX control hardware.

This document is intended to provide information to assist you in planning and designing the installation of your Experion LX control hardware. Control hardware is an umbrella term used to refer to the Honeywell control and input/output components that can be supplied with an Experion LX system.

This guide complements the *Station Planning Guide* that provides planning and design topics for Experion LX servers and clients.

Release Information

Document Name	Document ID	Release Number	Publication Date
Control Hardware Planning Guide - EXDOC	EXDOC-XX23-en-110A	110	February 2014

Document Category
Planning and Design

References

The following list identifies all documents that may be sources of reference for material discussed in this publication.

Document Title
<i>Station Planning Guide</i>
<i>FTE Overview and Implementation Guide</i>







Support and Other Contacts







People's Republic of China

Contact: Honeywell Global TAC – China
Phone: +86- 21-2219-6888
800-820-0237
400-820-0386
Mail: Honeywell (China) Co., Ltd
33/F, Tower A, City Center, 100 Zunyi Rd.
Shanghai 200051, People's Republic of China
Email: Global-TAC-China@honeywell.com

Symbol Definitions

The following table lists those symbols used in this document to denote certain conditions.

Symbol	Definition
	ATTENTION: Identifies information that requires special consideration.
	TIP: Identifies advice or hints for the user, often in terms of performing a task.
	REFERENCE -EXTERNAL: Identifies an additional source of information outside of the bookset.
	REFERENCE - INTERNAL: Identifies an additional source of information within the bookset.
CAUTION	Indicates a situation which, if not avoided, may result in equipment or work (data) on the system being damaged or lost, or may result in the inability to properly operate the process.
	CAUTION: Indicates a potentially hazardous situation which, if not avoided, may result in minor or moderate injury. It may also be used to alert against unsafe practices. CAUTION symbol on the equipment refers the user to the product manual for additional information. The symbol appears next to required information in the manual.
	WARNING: Indicates a potentially hazardous situation, which, if not avoided, could result in serious injury or death. WARNING symbol on the equipment refers the user to the product manual for additional information. The symbol appears next to required information in the manual.

Symbol	Definition
	<p>WARNING, Risk of electrical shock: Potential shock hazard where HAZARDOUS LIVE voltages greater than 30 Vrms, 42.4 Vpeak, or 60 VDC may be accessible.</p>
	<p>ESD HAZARD: Danger of an electro-static discharge to which equipment may be sensitive. Observe precautions for handling electrostatic sensitive devices.</p>
	<p>Protective Earth (PE) terminal: Provided for connection of the protective earth (green or green/yellow) supply system conductor.</p>
	<p>Functional earth terminal: Used for non-safety purposes such as noise immunity improvement. NOTE: This connection shall be bonded to Protective Earth at the source of supply in accordance with national local electrical code requirements.</p>
	<p>Earth Ground: Functional earth connection. NOTE: This connection shall be bonded to Protective Earth at the source of supply in accordance with national and local electrical code requirements.</p>
	<p>Chassis Ground: Identifies a connection to the chassis or frame of the equipment shall be bonded to Protective Earth at the source of supply in accordance with national and local electrical code requirements.</p>

Contents

1.	INITIAL PLANNING AND DESIGN ACTIVITIES.....	15
1.1	Getting started.....	15
	Review Experion LX capabilities	15
	General Prerequisites.....	15
1.2	Schedules and responsibilities	17
	Pre-installation schedule	17
	Customer responsibilities	18
1.3	Shipping and receiving.....	19
	Shipping	19
	Environmental considerations	19
	Cost.....	19
	Receiving	19
	Moving.....	19
	Unpacking	20
	Warehousing	20
2.	CONTROL NETWORK CONSIDERATIONS	21
2.1	Communications network.....	21
	New or existing network	21
2.2	Identifying topology diagram symbols	21
	About the symbols.....	21
2.3	Experion LX Network Topologies.....	24
	Configuration Rules.....	24
3.	SUPERVISORY NETWORKS	27
3.1	About Supervisory networks	27
3.2	Fault Tolerant Ethernet (FTE) Support.....	27
3.3	FTE Supervisory Network Topologies.....	27
4.	INPUT/OUTPUT (I/O) NETWORK CONSIDERATIONS	29

Contents

4.1	Series 8 I/O Topologies	29
	Series 8 I/O with C300	29
4.2	HART I/O Topologies	33
	HART Series 8 I/O	33
5.	COMMUNICATION MEDIA	35
5.1	Fault Tolerant Ethernet	35
6.	SERIES 8 HARDWARE CONFIGURATION	37
6.1	Planning your Series 8 control system	37
	Possible Series 8 system configurations	37
	Configuration rules (SCS)	37
	Series 8 cabinet layout examples.....	38
	Configuration rules (IOL).....	39
6.2	Selecting Series 8 Cabinet Hardware	41
	Dual-Access, 0.8 meter (32 inches)-deep cabinet parts.....	41
6.3	Selecting power entry accessories	41
	Circuit Breaker Box entry guidelines	41
6.4	Selecting fan assembly kits	42
6.5	Selecting the Series 8 Power System	42
	Series 8 power system parts	42
6.6	Power Distribution Subsystem	43
6.7	C300 Controller Memory Backup	43
	Memory backup assembly cabling guidelines	43
	Memory backup hold-up times	44
	Replacing RAM charger batteries (NiMH batteries)	44
6.8	Series 8 DC Power Connections and Indicators	45
6.9	Series 8 Power Sub-System Alarm Contacts and LED Activation Levels	45
6.10	Series 8 System Cabling	45
	Cable color coding schemes	45
	I/O Link Cables	47
	Ethernet cables	49
6.11	Agency Approvals for Series 8 Cabinets	50
6.12	Series 8 Hardware Attributes	50
	Power draw and heat dissipation ratings for Series 8 components	50

6.13	Series 8 Hardware Grounding Considerations	51
	Grounding basics	51
	Types of Grounding Systems	52
	Energy limiter for dissimilar grounds	54
	Isolation.....	55
	Codes and references	55
	Two AC power sourcing methods.....	55
	Series 8 cabinet safety ground connections.....	55
7.	SITE SELECTION AND PLANNING	59
7.1	Planning for General Considerations	59
	Location.....	59
	Interim development location	59
	Facilities	59
	Insurance and zoning	59
7.2	Planning for Environmental Considerations.....	59
	Corrosion and dust.....	60
	Fire prevention	60
	Lightning protection.....	60
	Temperature and humidity	60
	Ventilation and filtration	60
	Vibration	60
7.3	Planning for Power and Grounding	61
	Compliance	61
	Circuit capacities	61
	Outlet capacities.....	61
	Multiple systems.....	61
	Convenience outlets.....	61
	Honeywell products	62
	General grounding guidelines.....	62
	About Lightning Grounds.....	63
	Lightning Ground Example (General Purpose Area)	63
7.4	Planning Your Cabling and Wiring.....	64
	Cabling and wiring.....	64
8.	PLANNING TO MINIMIZE ESD/EMI	67
8.1	Introduction	67
8.2	Planning for Static Electricity Minimization	67
	Ways to reduce electric static discharge	67
8.3	Planning for Interference Minimization.....	68

Contents

General considerations	68
Magnetic interference	68
Electromagnetic and radio frequency interference	68
8.4 Planning for Power Distribution	68
Transformer connections	68
Monitoring the master control relay	71
Sizing the transformer	71
Transformer separation of power supplies and circuits	71
Isolation transformers	72
Constant-voltage transformers	73
Transformer ground connections	73
8.5 Suppressing Power Surges.....	74
Why do they occur?	74
Surge-suppressors.....	74
Ferrite beads.....	74
Typical suppression circuitry	74
Examples	75
8.6 Planning Enclosure Lighting.....	76
Minimizing fluorescent lamp interference	76
8.7 Avoiding Unintentional Momentary Turn-on of Outputs.....	77
Minimizing the probability	77
Minimizing the effect	78
Testing the minimization	78
9. CONTROL PROCESSING CONSIDERATIONS.....	79
9.1 Control Processor Load Performance	79
Background.....	79
Load performance calculation example.....	79
10. APPLICATION LICENSING CONSIDERATIONS.....	81
10.1 Licensing Overview	81
10.2 Viewing Licenses	81
10.3 License Validation	83
Licensing at Configuration time	83
Licensing at Load time	83
Multiple Block Load scenario	84
Attempting to launch an Engineering Tool when the license limit is reached	84
Handling Application failures.....	84
Maintaining Licensing Information.....	84

10.4	Online License Change.....	84
11.	APPENDIX A.....	85
11.1	Corrosion Protection Planning	85
	Conformal coating versus corrosion	85
	G3 rating	85
	Gas concentrations	86
	Harsh Environment Enclosure.....	86
	Model and assembly numbering schemes for conformal coating	87

Contents

Tables

Table 1 Callout descriptions for Figure 3757
Table 2 Cabling/routing procedures.....64
Table 3 Control Processor load performance calculation example79

Figures

Figure 1 FTE Flat network architecture (entry level)	27
Figure 2 FTE Hierarchal (high capacity)	28
Figure 3 HART Series 8 I/O Topology	33
Figure 4 Typical AC power source through mains panel with safety ground bus and AC safety (mains) ground rod.	53
Figure 5 Typical AC power source through mains panel with safety ground bus, AC safety (mains) ground, supplementary ground, master reference ground, and lightning ground rods.....	54
Figure 6 Typical safety ground connections in Series 8 cabinet.....	56
Figure 7 Typical power and ground connections to AC terminal block in Series 8 cabinet	57

Contents

1. Initial planning and design activities

1.1 Getting started

Review Experion LX capabilities

Complement the information in this document with the data in the *Station Planning Guide* to cover all aspects of a Experion LX installation.



REFERENCE - INTERNAL

Refer to the *Station Planning Guide* for planning and design topics for Experion LX servers and clients as well as information about adding third-party controllers.

General Prerequisites

Before designing a system, collect as much information as possible about the plant and its processes. This helps to define the specific control requirements for your plant. The following mix of skills and plant data are general prerequisites for the planning process.

Skill or Data	Purpose
Understanding of Basic Monitoring and Control Concepts	<ul style="list-style-type: none">Need a basic knowledge of the concepts of process monitoring and control to adequately plan your control system installation.Need a Process Narrative to provide a literal description of the plant processes.
Piping and Instrumentation Diagrams (P&IDs)	<ul style="list-style-type: none">Shows the equipment used in the plant and how it is connected, in schematic format.Can be used to break down large processes into constituent subprocesses.
Flow Diagrams	<ul style="list-style-type: none">Describes the sequence of events in plant processes.Defines how the control system should be used to interact with the processes.

1. Initial planning and design activities

1.1. Getting started

Skill or Data	Purpose
Engineering and System Specifications	<ul style="list-style-type: none">• Describe operational requirements; that is, what the system needs to do.• Describe when and how your Experion LX system will be implemented.• Describe details of the Experion LX system's hardware and software.
Other Resources	<ul style="list-style-type: none">• Wiring diagrams,• Computer-aided drafting (CAD) schematics of the plant,• Other plant layout diagrams, often showing electrical wiring configurations, the location of power cables, and other helpful information.• Subject-matter-experts (typically engineers) in the process, control, instrumentation, and so on, who can provide details that might be missing from schematics and diagrams.• Process operators who can often tell you how the plant is run, and provide valuable insight into the design of custom displays.

1.2 Schedules and responsibilities

Pre-installation schedule

After you have selected a suitable location for your system equipment, establish a schedule incorporating all phases of site preparation and system installation work. Use the following checklist to schedule and monitor the events that must occur prior to the actual delivery and installation of your system.

Event	Date	
	<i>Plan</i>	<i>Actual</i>
Determine whether building modification or construction is required.		
Verify building-access dimensions.		
Determine the requirements, if any, of additional electrical power, power conditioning, or grounding; arrange for its installation.		
Determine the locations, pathways, and types of communications data-lines; arrange for their installation.		
Implement ElectroStatic Discharge (ESD) and ElectroMagnetic Interference (EMI) reduction measures.		
Complete corrosion analyses for site location.		
Determine whether air conditioning is required, then arrange for its installation.		
Order cables.		
Verify equipment delivery and installation schedule.		
Order power panels.		
Order the required quantity and type of data-line communications equipment necessary for your system application.		
Order furniture, storage equipment, and other similar equipment to support your needs.		
<i>Thirty days before delivery, complete the following tasks:</i>		
Install and test primary power equipment.		

1. Initial planning and design activities

1.2. Schedules and responsibilities

Event	Date	
	<i>Plan</i>	<i>Actual</i>
Install lighting fixtures.		
Complete the support facilities (such as media storage).		
Verify that all required construction, electrical and communications wiring, air conditioning, fire, and smoke-detection equipment installation have been completed.		

Notify your Honeywell Account Manager of your facility's state of readiness, or of any possible contingencies that might delay installation.

Customer responsibilities

In general, you are responsible for preparing your facility as outlined in this guide, so that the Experion LX system can be properly installed. Your responsibilities as a customer are as follows:

- Install this equipment in accordance with the requirements of the National Electrical Code (NEC), ANSI/NFPA 70, or the Canadian Electrical Code (CEC), C22.1.
- To furnish and install (at your expense, and sole responsibility) all internal building wiring (including power and signal cables) in accordance with the NEC or the CEC.
- To install any power and signal cables according to the NEC, CEC, and other local regulations and requirements.
- Before shipment, to prepare the premises for installation; to provide installation to include space, a stable power supply, connectors, cables, and fittings.
- For equipment that Honeywell installs, to provide necessary labor for unpacking and placement of equipment and packing for return.
- To provide equipment that is not manufactured or supplied by Honeywell.
- Ensure that you follow the instructions specified by the manufacturer to protect the system equipment from being impaired.

1.3 Shipping and receiving

Shipping

Honeywell ships and insures the Experion LX System components.

Environmental considerations

Through-out the transit process, the environment must be monitored; correction must be made if the following controller equipment ratings are exceeded:

- Temperature Range: -55° to 85°C (-67° to 158°F)
- Humidity Range: 5 to 95% RH non-condensing



CAUTION

The humidity range in a corrosive atmosphere will vary.

Cost

The following issues should be taken into account in determining shipping costs:

- The shipping distance and the weight of the equipment (responsibility of the purchaser).
- Listed equipment weights are adjusted up to 25 percent higher to allow for the weight of: cables, operating supplies, shipping materials, spare parts, and test equipment.
- Mileage figures used in determining cost can be obtained from the *Household Goods Carriers Bureau Mileage Guide*, or from an automobile road atlas.

Receiving

Depending on the tariffs in effect, the carrier may be responsible for placing and delivery of the system equipment at the specified facility according to the tariffs in effect.

Moving

Guidelines for moving equipment into your facility (particularly for large systems) are described below:

- Check the maximum equipment dimensions against possible obstacles; these may include such things as narrow hallways, restricted doorways, and small elevators.

1. Initial planning and design activities

1.3. Shipping and receiving

- Check for availability and readiness of any necessary devices for moving equipment to or within your facility. In most cases, the system and its equipment will be accommodated by the usual equipment-moving devices.
- Delays can be avoided by giving the delivery carrier advance notice of any special requirements. If notified in advance, Honeywell can alert the carrier on your behalf.

Unpacking

When unpacking the equipment, check the shipment against the invoice; immediately notify your Honeywell Account Manager of any discrepancies.

If a Product Registration Label (containing the Model Number and Serial Number of the component) is affixed to the shipping carton when received, remove and return it to Honeywell at the noted address to ensure follow-up service and support.

Warehousing

In some instances, it may be necessary to temporarily store the system components before installation. In this event, keep the factory wrapping intact to minimize humidity. If it is necessary to unseal the equipment for customs or receiving, add more desiccant; then reseal the package. Ensure that the selected storage area does not subject the equipment to environmental extremes beyond those listed in the previous section.

2. Control network considerations

2.1 Communications network

New or existing network



The first thing to consider when designing a control system network is whether the system will be incorporated into an existing network, or a new network will be implemented.

- If planning a new network, you need to consider issues such as the network architecture to use.
- If planning to use an existing network, you will have to determine how to integrate the networks as seamlessly as possible. If the existing network has a system administrator, they should help with the integration.
- If a complex network is being planned, it might be advisable to consult professional network designers. Honeywell can design and implement your network, if desired.









2.2 Identifying topology diagram symbols

About the symbols





The symbols listed in the following table are used to simplify the node and component references to reduce the size and enhance the readability of the topology diagrams included in this document.

If Symbol is . . .	Then, it represents
<i>Native Experion LX Computer-Based Components</i>	
	Experion LX Server
	Redundant Experion LX Server
	Experion LX Console Station
<i>Experion LX Level 3/Level 4 Application Components</i>	

2. Control network considerations
 2.2. Identifying topology diagram symbols

If Symbol is . . .	Then, it represents
	Experion LX Application Server
	PHD Server
	Experion LX eServer
	Experion LX Desktop Server
	Application Point Server
	Application Server
	Experion LX Desktop Workstation
<i>Experion LX Series 8 Embedded Control Components</i>	
	C300 Controller
	Redundant C300 Controller
	Series 8 I/O

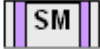
2. Control network considerations
 2.2. Identifying topology diagram symbols

If Symbol is . . .	Then, it represents
	
	Redundant Series 8 I/O
Miscellaneous Embedded Control Components	
	Fail Safe Controller (FSC)
	Safety Manager
Miscellaneous Network Components	
	Network Firewall
	Network Security Lock/Key

2. Control network considerations

2.3. Experion LX Network Topologies

2.3 Experion LX Network Topologies

Not all network combinations are shown, but the examples, and the associated Configuration Rules, provide you with the necessary guidelines to understand how Experion LX systems may be configured.

Configuration Rules

Reference	Description
1	Experion LX users may use Windows group-based accounts, Windows accounts, or Traditional operator accounts. If using Windows accounts, using a Windows Domain controller and Domain based Windows accounts is strongly recommended for account maintenance, especially as the number of nodes increases.
2	Experion LX services use local Windows accounts.
3	All Experion LX nodes are configured to be part of the same Workgroup or Domain, if used.
4	Only Windows 2008 Server is supported as the operating system for the Experion LX server.
5	Only Windows 2007 Operating System is supported as the operating system for the Experion LX Console Station.
6	Server may use a Dual CPU configuration.
7	In a Domain configuration, all nodes in the Experion LX cluster should be time synchronized with the Domain controller or dedicated NTP Server.
8	In a workgroup configuration, the time must be synchronized between redundant servers and all console stations in the Experion LX cluster. They should also be synchronized with any other clusters connected through the Distributed Server Architecture (DSA).
9	FTE requires the use of qualified switches. Refer to the FTE Technical Data and Specification document for the latest FTE configuration rules.
10	Only one System Event Server (SES) must be installed per FTE Community. If Experion LX servers are redundant, the SES is installed on both servers. The System Management runtime software should be installed on all nodes in the Experion LX cluster that are to be monitored by the System Event Server. The time should be synchronized between the redundant servers and all Experion LX cluster nodes being monitored by the System Event Server.

2. Control network considerations
2.3. Experion LX Network Topologies

Reference	Description
11	The System Management runtime software should be installed on all nodes that are to be monitored by the System Event Server. The time should be synchronized between the redundant servers and all Experion LX cluster nodes being monitored by the System Event Server.
12	The High Security Policy Workstation Package should be installed on the redundant servers.

2. Control network considerations
2.3. Experion LX Network Topologies

3. Supervisory Networks

3.1 About Supervisory networks

The supervisory network is used for communication between Experion LX servers and Controllers. The Controllers are the Series C form factor C300 Process Controller that is running on a separate computer node. This network is dedicated for Server to Controller communications including CPM peer-to-peer with other CPMs through a Fault Tolerant Ethernet (FTE) connection.

3.2 Fault Tolerant Ethernet (FTE) Support

The Experion LX supports using Honeywell's Fault Tolerant Ethernet network as its preferred supervisory network. Refer to the *Fault Tolerant Ethernet Overview and Implementation Guide* for more information.

3.3 FTE Supervisory Network Topologies

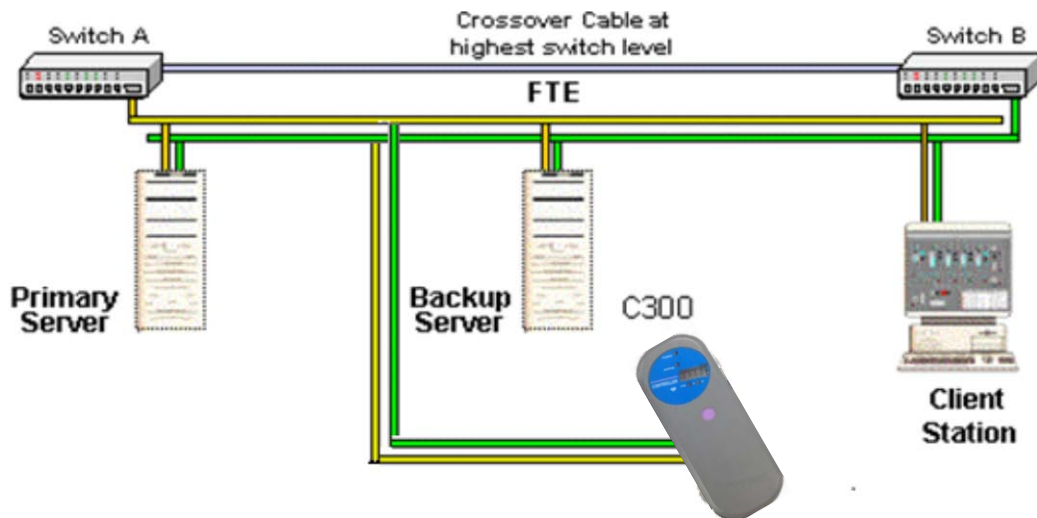

Figure 1 FTE Flat network architecture (entry level)

3. Supervisory Networks
3.3. FTE Supervisory Network Topologies

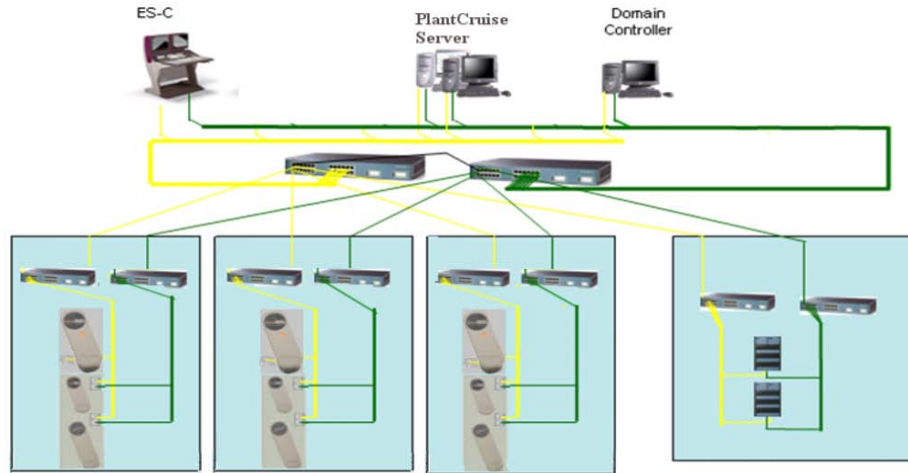

Figure 2 FTE Hierarchical (high capacity)



4. Input/Output (I/O) Network Considerations

The Series 8 I/O and Fault Tolerant Ethernet (FTE) media form the basis for the I/O network for C300 Controllers, which includes HART I/O interfaces.

4.1 Series 8 I/O Topologies

Series 8 I/O with C300

The following topologies are examples of how Series 8 I/O is integrated with the C300 Controller. The C300 supports two I/O Link interfaces and each or both of these can be used with Series 8 I/O. The Series 8 I/O is supported when the link is configured at 750 Kbps. This means that these two I/O types cannot be shared on the same I/O Link.

Description	Diagram
<p>Non-Redundant C300 with One Series 8 I/O Link</p>	 <p>The diagram shows a C300 controller on the left with a single blue line labeled 'SERIES_8_IO_TYPE' extending from its I/O port to two Series 8 I/O devices on the right. The devices are connected to each other and to the controller's link.</p>
<p>Non-Redundant C300 with Two Series 8 I/O Links</p>	 <p>The diagram shows a C300 controller on the left with two separate blue lines labeled 'SERIES_8_IO_TYPE' extending from its I/O ports. Each line connects to two Series 8 I/O devices on the right, for a total of four devices.</p>
<p>Redundant C300 with One Series 8 I/O Link</p>	<p>(Diagram content is not visible in the provided image)</p>

4. Input/Output (I/O) Network Considerations

4.1. Series 8 I/O Topologies

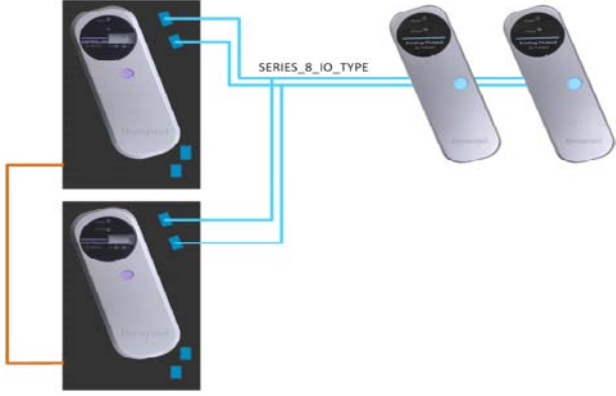
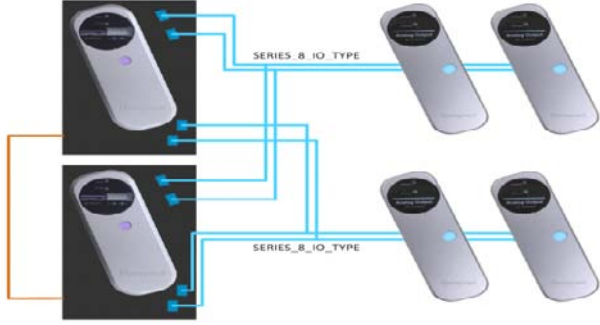
Description	Diagram
	 <p>The diagram illustrates a single C300 unit (represented by a vertical rectangle) connected to two Series 8 I/O links (represented by two vertical rectangles). Blue lines represent the I/O links, and an orange line represents the power supply. The label 'SERIES_8_IO_TYPE' is shown between the C300 unit and the I/O links.</p>
<p>Redundant C300 with Two Series 8 I/O Links</p>	 <p>The diagram illustrates two C300 units (represented by two vertical rectangles) connected to four Series 8 I/O links (represented by four vertical rectangles). Blue lines represent the I/O links, and an orange line represents the power supply. The label 'SERIES_8_IO_TYPE' is shown between the C300 units and the I/O links.</p>

Configuration Rules (CIO)

Reference	Description
CR_CIO.0	Multiple Series 8 I/O Links cannot be conjoined together, except for the same logical link from a Primary and Secondary C300 pair
CR_CIO.1	Series 8 I/O has a maximum of 2000 LUs per second

4. Input/Output (I/O) Network Considerations

4.1. Series 8 I/O Topologies

Reference	Description
CR_CIO.2	The maximum number of Primary Series 8 IOMs per C300 I/O Link is 40, within the Link Unit specification.
CR_CIO.3	Each Series 8 IOM counts as 1 IO Unit (IOU) in the C300 I/O limit calculation.
CR_CIO.4	Any mix of the supported Series 8 I/O modules can be used on a Series 8 I/O IOLINK.
CR_CIO.5	Either C300 I/O Link can be configured as a SERIES_8_IO_TYPE. For example, both can be used for Series 8 I/O, or one of each type in any orientation of link 1 and 2.
CR_CIO.6	All Series 8 I/O channels must be contained in Control Modules that reside in the same C300 CEE that hosts the I/O Link where the Series 8 IOMs reside. This means that two different C300s cannot share an I/O Link or the IOMs residing on that link

Series 8 IOM support

The following table lists the Series 8 IOMs that are supported in Experion LX R110 by the C300 Controllers.

IOM Model	IOM Type	Description	Number of Channels
8U-PAIHA1 8C-PAIHA1	AI-HART	Analog Input with HART	16
8U-PAIMA1 8C-PAIMA1	AI-TC/RTD	TC/RTD Analog Input	16
8U-PAOHA1 8C-PAOHA1	AO-HART	Analog Output with HART	16
8U-PDILA1 8C-PDILA1	DI-24	Digital Input 24VDC	32
8U-PDISA1 8C-PDISA1	DI-SOE	Digital Input Sequence of Events (24 VDC)	32
8U-PDODA1 8C-PDODA1	DO-24V	Digital Output 24 VDC	32
8U-PDIPA1 8C-PDIPA1	DI-PA	Digital Input Pulse Accumulation	32

4. Input/Output (I/O) Network Considerations

4.1. Series 8 I/O Topologies

IOM Model	IOM Type	Description	Number of Channels
<p>Notes:</p> <p>1. While other IOMs can be redundant or non-redundant, this IOM is ONLY available as a non-redundant IOM.</p>			

4.2 HART I/O Topologies

HART Series 8 I/O

The following topology represents Series 8 HART AI and AO IOMs residing on the C300 750 Kbps I/O Link in both redundant and non-redundant IOM configurations. Access to these HART IOMs and the attached devices is fully qualified by the HART MUX application.

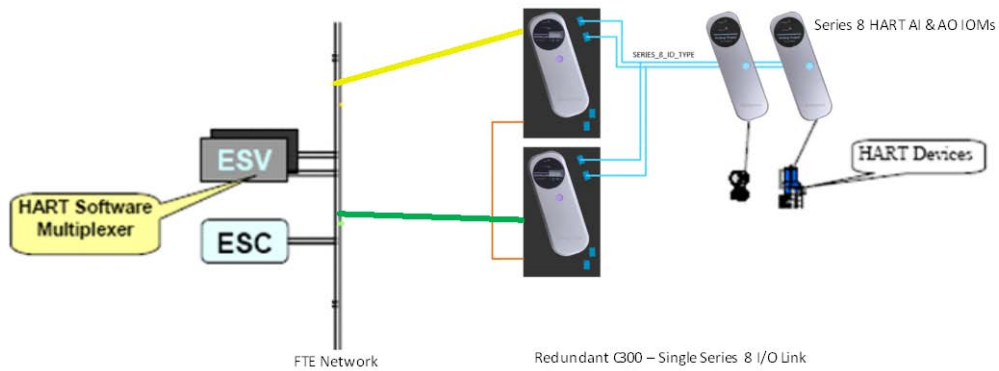

Figure 3 HART Series 8 I/O Topology

Configuration Rules (HSC)

Reference	Description
CR_HSC.0	Series 8 I/O's fundamental AI and AO channel blocks support HART.
CR_HSC.1	To enable HART, the channel must be assigned to a HART IOM and HENABLE must be set to TRUE.
CR_HSC.2	The Series 8 HART IOMs have been added to the IOLINK bandwidth calculation spreadsheet. Some of the data to be entered is dependent on how many actual HART devices are configured and used.

5. Communication media

5.1 Fault Tolerant Ethernet

Honeywell's unique Fault Tolerant Ethernet (FTE) solution offers a full function replacement for present control networks using common Ethernet equipment. FTE technology creates a network with no single point of hardware or software failure. It is transparent to open applications and supports TCP, UDP, IP Multicast, and Broadcast. Honeywell supplies the patented software, the dual network interface card, switches, a media converter, CAT5 and fiber optic cables, as shown in the following figure. Some general installation considerations are:

- An FTE base switch has 12 ports, expandable up to 96 ports in 12-port increments
- The FTE network can consist of up to 511 FTE nodes (dual-connected)
- A firewall is required between an FTE network and any other network.
- The cable options include shielded twisted pair (STP) and fiber optic. These cables are recommended for best noise immunity and network performance, and are required for CE Mark.

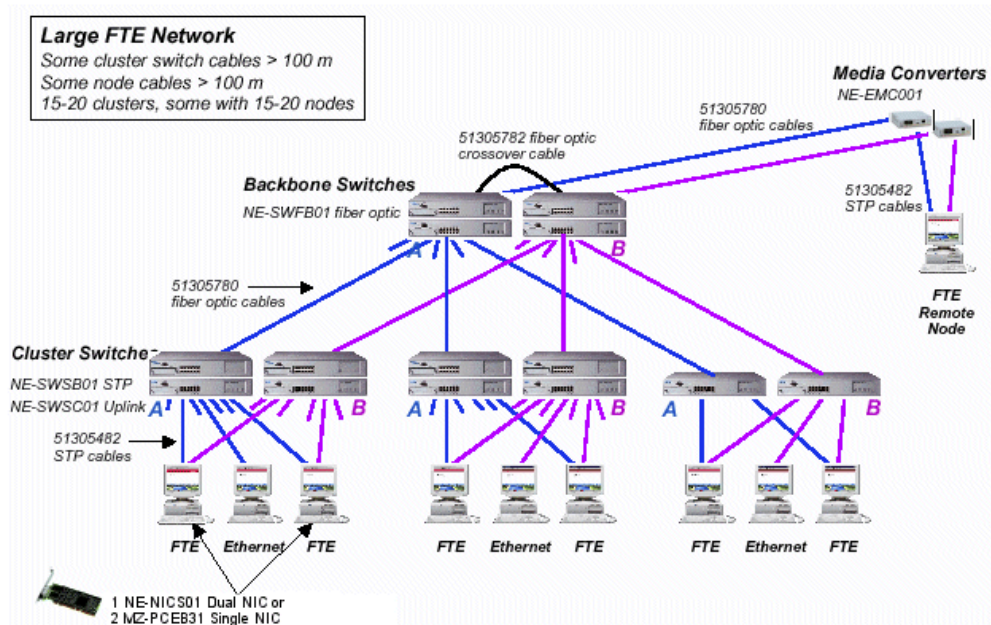

5. Communication media
5.1. Fault Tolerant Ethernet



REFERENCE - EXTERNAL

For more information about Honeywell's Fault Tolerant Ethernet, refer to the *Specification and Technical Data*. Note that the document number may be different for the most current issue.

6. Series 8 hardware configuration

6.1 Planning your Series 8 control system

Possible Series 8 system configurations

The following table summarizes the hardware that can be included in a standard Series 8 control system.

Standard Series 8 System Hardware
Series 8 Cabinet or Cabinet Complex
Series 8 Power System
C300 Controller including IOTA
Series 8 I/O including IOTA

Configuration rules (SCS)

Reference	Description
CR_SCS.0	Each C300 controller can support two I/O Links.
CR_SCS.1	Each I/O Link can support Series 8 I/O.
CR_SCS.2	Each I/O Link can support up to 40 redundant or non-redundant IOPs/IOMs.
CR_SCS.5	The I/O Link cables must not leave the physical confines of the cabinet complex. They are not permitted to exit the front, rear, left side, right side, top, or bottom of the cabinet or cabinet complex.
CR_SCS.6	All of the cabinets connected together in a complex must be the same type - Either single or dual access.
CR_SCS.7	A fan assembly must be used on every side of every cabinet and cabinet complex.
CR_SCS.8	A Series 8 dual-access cabinet is allowed to have a Series 8 power system in both cabinet sides.

6. Series 8 hardware configuration
6.1. Planning your Series 8 control system

Series 8 cabinet layout examples

The following illustrations are examples of Series 8 cabinet layouts for given standard and hybrid Series 8 control system configurations.

Standard Series 8 system with C300 and Series 8 I/O (four columns per cabinet side)

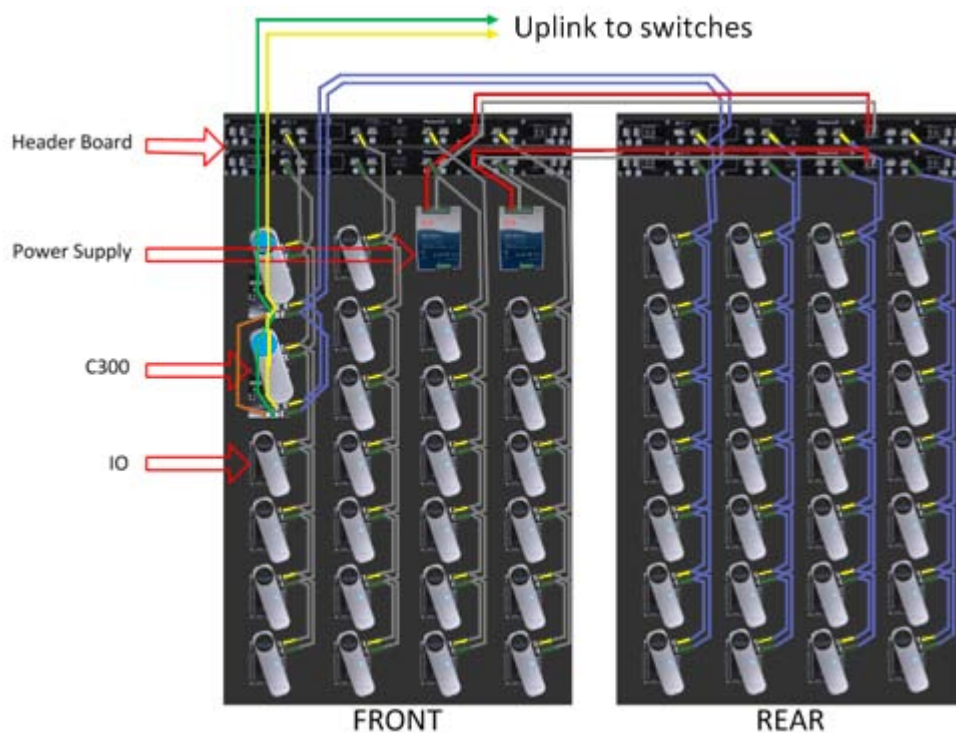

Standard Series 8 system with C300 and Series 8 I/O (three columns per cabinet side)

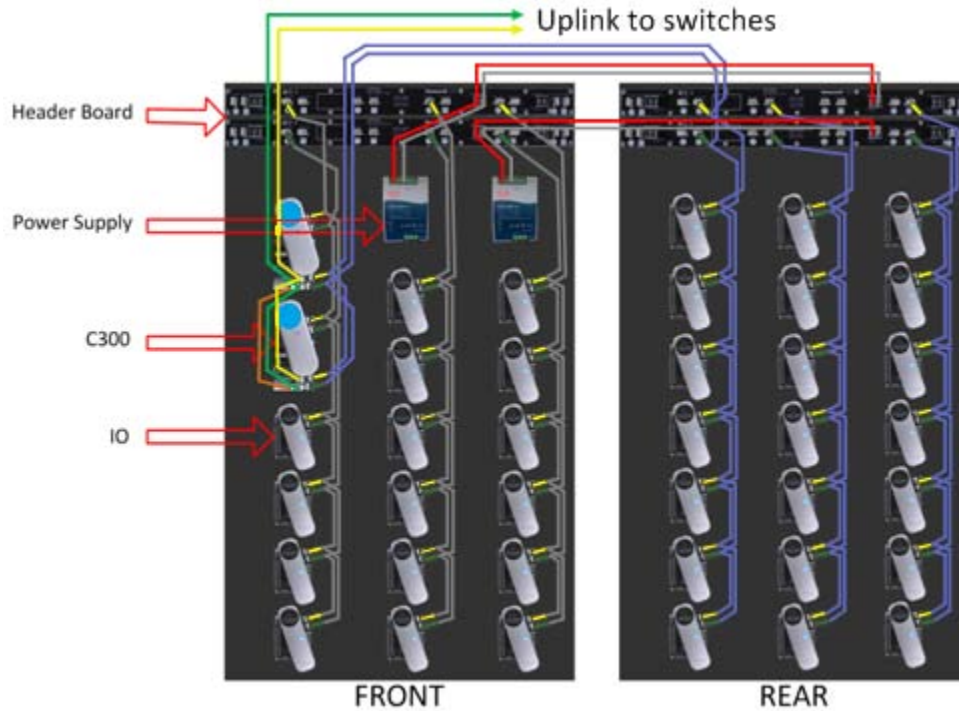

Configuration rules (IOL)

Reference	Description
CR_IOL.0	The I/O Link is a redundant serial communications and power supply subsystem that is the interface between the C300 Controller and its Series 8 I/O. It is a multi-drop network operating at 750 Kilobits per second (Kbps) for Series 8 I/O. The C300 Controller has two I/O Link ports identified as I/O Link 1 (IOL1) and I/O Link 2 (IOL2). The Series 8 I/O IOMs plug into different size IOTAs and use a simple hierarchy of interconnected cables for I/O Link distribution between assemblies.
CR_IOL.1	By default, I/O Link 1 (IOL1) is distributed first. The IOTAs that are to be connected to IOL1 are positioned in the mounting plates first; followed by the IOTAs that will be connected to I/O Link 2 (IOL2). IOL2 may or may not be used depending on the number of IOTAs on IOL1 and the communications load on IOL1. By default, IOL1 and IOL2 will not be mixed in a vertical set of two columns of the mounting plate (although they could be). I/O Links should not be mixed in a single column of the mounting plate. The IOL1 and IOL2 cables can be co-mingled in any physical (wireway) location.

6. Series 8 hardware configuration
 6.2. Selecting Series 8 Cabinet Hardware

Reference	Description
CR_IOL.3	<p>IOTAs in a Series 8 system are physically positioned in much the same way. Since the I/O Link cables connect to multiple IOTAs, there are some additional rules to follow. In a given system consisting of a C300 controller (and normally its redundant partner) and all the attached I/O, you should physically position IOTAs starting at the top of the mounting plate in the left column (the default case) and filling from L to R. The layout is per cabinet side and proceeds from cabinet side to cabinet side regardless of where the next side is located (in the rear of the same cabinet or in the next adjacent cabinet). There are three or four columns per cabinet side. IOTAs should be mounted in the following order:</p> <ul style="list-style-type: none"> C300, Primary C300, Secondary C300 Memory Backup Assembly HLAI, Redundant AO, Redundant HLAI, Non-Redundant AO, Non-Redundant 24V DI, Redundant (See Note 2) 24V Bussed DO, Redundant (See Note 2) 24V DI, Non-Redundant (See Note 2) 24V Bussed DO, Non-Redundant (See Note 2) <p>At this point, go to the top of a new mounting plate.</p>
CR_IOL.6	<p>The first cable pair connects to the IOL2 connectors of the C300 IOTA(s) and goes from there to the top of the IOTA channel. This cable pair is a Series 8 Drop cable pair (part 51202971-110).</p>
CR_IOL.9	<p>IOTAs associated with field wiring over 30 volts, must be physically separated from IOTAs associated with field wiring under 30 volts. This allows the field wiring associated with one group of IOTAs to be routed away from the field wiring associated with the other group of IOTAs to minimize electrical interference between the two groups. This makes it easier to meet any electrical codes requiring separation of such wiring. This can be done by keeping each group of IOTAs on their own separate columns of mounting plates or by grouping them at each end of the same column of mounting plate, as long as this does not create a similar conflict with IOTAs on the mounting plate above or below.</p>
<p>Notes:</p> <p>1 If the hardware configuration does not permit analog I/O and digital I/O in the same column of mounting plate (with co-mingled field wiring), the 24V digital I/O should start at the top of the next column of mounting plate.</p> <p>2 This order applies if the relays are switching 120 or 240 Vac (or any voltage above 30 Vdc).</p>	

Reference	Description
3	Note that the transition to IOL2 can occur anywhere in the following list depending on the number of IOTAs and the communication load on IOL1.

6.2 Selecting Series 8 Cabinet Hardware

The Series 8 cabinets are available in single-access and dual-access models with kits available for complexing up to four cabinets together. The cabinets include materials from the manufacturer Rittal as well as from Honeywell.

Dual-Access, 0.8 meter (32 inches)-deep cabinet parts

The following table lists the model or part numbers for the hardware that can be used to construct a dual-access Series 8 cabinet.

Description	Model	Part Number
Series 8, Dual-Access, Cabinet Framework with front and rear panel	8U-CBFR01-CN	51202917
Cabinet Base	8U-CBBA01-CN	51202920
Cabinet Side panel	8U-CBSP01-CN	5102918
Cabinet top panel, panel without fan	8U-CBTP01-CN	51202919-100
Cabinet Light Assy	8U-CBTP02-CN	51202919-200

6.3 Selecting power entry accessories

You can supply AC line power wiring through **Circuit Breaker Box (51307039)** to the Series 8 cabinet power supplies and fan assemblies.

Circuit Breaker Box entry guidelines

With the **Circuit Breaker Box**, you can use Circuit Breaker in the Series 8 Circuit Breaker Box to turn the power supply **On** or **Off**.

If You Have . . .	Then, . . .
Two Series 8 Power Supply Modules in the Power System Rack.	Connect one user-supplied ac line power cord (L1, L2, and Ground) through a cabinet side to the input side of Port 1 on the AC terminal

6. Series 8 hardware configuration

6.4. Selecting fan assembly kits

If You Have . . .	Then, . . .
	block. Connect the second user-supplied ac line power cord (L1, L2, and Ground) through a cabinet side to the input side of Port 2 on the AC terminal block.

6.4 Selecting fan assembly kits

Depending on the rating of the AC line power voltage, you must optionally install the fan assemblies listed in the following table in Series 8 cabinet side containing Series 8 hardware.

Each fan assembly kit contains two fans and mounts in the single, rectangular cutout in the top cover of each side of the Series 8 cabinet. A dual-access cabinet has two cutouts.

Description	Model or Part Number
Fan Assembly Kit, 2 Fans and Cables (240 VAC, 50-60 Hz)	51154874

6.5 Selecting the Series 8 Power System

The Series 8 Power System provides +24 VDC power to compatible assemblies through header board in the top of one or more cabinet.

Series 8 power system parts

The power systems provide 24 VDC power to assemblies that are compatible in one or more cabinet sides. Each power system includes the following:

- The metal piece (51154886) that holds power supplies
- Two 20A Power Supply 120/240 VAC (8U-PWSP01-CN or 8U-PWSP02-CN)

6.6 Power Distribution Subsystem

The power distribution subsystem consists of the hardware listed in the following table to distribute 24 Vdc from a Series 8 power system to one or more columns of mounting plates in one or both sides of a cabinet containing the power system.

- The power system mentioned in Selecting Series 8 Power System section.
- Two header boards (51307186)

6.7 C300 Controller Memory Backup

The controller memory backup assembly consists of the following parts and provides up to 50 hours of memory backup to one or two connected C300 Controllers.

Description	Model or Part Number
<i>Spare/Loose Parts</i>	
RAM Charger Assembly	51454475-100
Cable, MBA to one C300 Controller, 30 inches (0.7 m) long	51202330-300
Cable, MBA to one C300 Controller, 84 inches (2 m) long	51202330-200

Memory backup assembly cabling guidelines

- You can use the 30-inch (0.7 meter) long cable to connect the MBA to C300, when the RAM charger mounting assembly is mounted adjacent to its associated C300 IOTA on the same column of mounting plate. Use the 84-inch (2 m) long cable when the RAM charger mounting assembly is **not** adjacent to its associated C300 IOTA on the same column of mounting plate.
- You can connect up to four C300s to the RAM charger mounting assembly using either the 30-inch (0.7 m) or 84-inch (2 m) long cables, as required. (You can only connect two C300s to the previous 51454475-100 model.)
- The 55-inch (1.4 m) long power cable restricts the mounting location of the MBA to the upper mounting plate on the left side of a cabinet side adjacent to the Series 8 power system.

6. Series 8 hardware configuration

6.7. C300 Controller Memory Backup

Memory backup hold-up times

The following table lists the hold-up time for a fully charged RAM battery charger depending on the number of C300 Controllers that are connected.

Number of C300s	Hold-Up Time in Hours	Hold-Up Time in Days
1	110	4.58
2*	55	2.23
3	36.6	1.52
4	27.5	1.14
* You can only connect up to two C300s to the previous 51454475-100 RAM Charger Assembly.		

Replacing RAM charger batteries (NiMH batteries)

The RAM battery charger provides standby power for the Series 8 C300 memory. The RAM battery pack consists of three NiMH (nickel-metal hydride cell) batteries with a connector that is installed into the Series 8 RAM battery charger IOTA. The NiMH batteries have a tendency to age over a period of time. Aging of the NiMH batteries can occur even if the batteries are regularly recharged throughout their lifetime. Therefore, the NiMH batteries should be replaced after every three years of operation.

Note that it is not necessary to remove power from the RAM charger while replacing the battery pack.

The version of the RAM battery charger:

- -100 RAM battery charger



CAUTION

Batteries may contain toxic materials that are not biodegradable. Therefore, batteries should be disposed off safely in accordance with local laws and regulations.

Replacing the -100 RAM battery charger

Perform the following steps to replace a -100 RAM battery charger.

Step	Action
------	--------

Step	Action
1	Remove completely the four captive screws holding the cover in place. Note: Hold the cover tightly because the battery pack is attached to the cover with Velcro.
2	Lift the cover away from the IOTA to remove the battery connector.
3	Remove the battery connector.
4	Remove the battery pack from the cover.
5	Replace the battery pack and secure it to the cover with Velcro.
6	Plug-in the battery pack connector.
7	Replace cover and tighten the four captive screws.

6.8 Series 8 DC Power Connections and Indicators

Refer to *Series 8 I/O User's Guide* for information related to the Series 8 Power Connections and Indicators.

6.9 Series 8 Power Sub-System Alarm Contacts and LED Activation Levels

Refer to *Series 8 I/O User's Guide* for information related to the Series 8 Power Sub-System alarm contacts and Led Activation Levels.

6.10 Series 8 System Cabling

Cable color coding schemes



The following topics show the color and symbols used for the various cables and connectors used in the Series 8 system

Ethernet connections



Function	Cable Color	Connector Boot Color	Text	Symbol on IOTA
FTE Link A	White	Yellow	FTEA	

6. Series 8 hardware configuration

6.10. Series 8 System Cabling

Function	Cable Color	Connector Boot Color	Text	Symbol on IOTA
		Yellow		
FTE Link B	White	Green	FTEB	
C300 Redundancy	White	Orange	REDUNDANCY	
GPS	White	Black	GPS	

I/O Link Connections

Function	Cable Color	Connector Label Color	Text	Symbol on IOTA
IOLINK1 Link A	Gray	Yellow	IOL1A	
IOLINK Link B	Gray	Green	IOL1B	
IOLINK2 Link A	Violet	Yellow	IOL2A	

Function	Cable Color	Connector Label Color	Text	Symbol on IOTA
IOLINK2 Link B	Violet	Green	IOL2B	
IOLINK 1 Jumper		Gray	(Jumper Number 1 to 40)	
IOLINK 2 Jumper		Violet	(Jumper Number 1 to 40)	

I/O Link Cables

You can connect the following types of I/O Link cables to the redundant I/O Link cable connector ports (IOL1A/B and IOL2A/B) on the C300 Controller IOTA:

- Series 8 I/O Link (750 KBaud), to support Series 8 IOMs in their IOTAs

Both types always require a pair of cables (Cable A and Cable B). See the previous section about cable color coding schemes.

Series 8 I/O Link cable types

The following table provides a summary of the types of I/O Link cables that are used in the Series 8 system.

Cable Name and Type	Description
Drop, 6 Connections on 6-inch Pitch	The Drop cable is a multi-drop cable that runs vertically in a mounting plate. Two drop cables can be plugged together to distribute the I/O Link in a pair of columns of the mounting plate. The top connector of the topmost drop cable plugs into a connector on the header board. Use this cable to connect to all the Series 8 IOTAs, which have three kinds of dimensions [6-inches (152 mm), 9-inches (229 mm) and 12-inches (305 mm)]. This cable connects C300s to header board and bypasses redundant Control Firewalls above.
Extension, 36 inches	An extension cable is used to extend the I/O Link to another cabinet side. It can plug into taps on a header board, the end of a header

6. Series 8 hardware configuration

6.10. Series 8 System Cabling

Cable Name and Type	Description
	board, or the bottom of a drop cable (although this is not a normal use). Extension cables are normally used for the purposes: <ul style="list-style-type: none"> To extend a header board to another cabinet side in a complex.

Series 8 I/O Link cable parts

Each I/O Link cable is available in an A version (marked yellow) and a B version (marked green). They are normally sold as a pair, since both are needed. The I/O Link 2 (IOL2) cable part numbers have similar tab numbers as the I/O Link 1 (IOL1) cables but with the second digit equal to 1 instead of zero.

Description	Model or Part Number
Series 8 I/O Link 1 (IOL1) Cable Assemblies	
Gray Drop Cable, 6 drops, 6-inch (152 mm) pitch, yellow label (cable A)	51202971-100
Gray Drop Cable, 6 drops, 6-inch (152 mm) pitch, green label (cable B)	51202971-101
<i>Cable pair consisting of one each of the preceding two cables</i>	<i>51202971-102</i>
Gray Extension Cable, 9-inches (229 mm) long, yellow label (cable A)	51202329-700
Gray Extension Cable, 9-inches (229 mm) long, green label (cable B)	51202329-701
<i>Cable pair consisting of one each of the preceding two cables</i>	<i>51202329-702</i>
Series 8 I/O Link 2 (IOL2) Cable Assemblies	
Violet Drop Cable, 6 drops, 6-inch (152 mm) pitch, yellow label (cable A)	51202971-110
Violet Drop Cable, 6 drops, 6-inch (152 mm) pitch, green label (cable B)	51202971-111
<i>Cable pair consisting of one each of the preceding two cables</i>	<i>51202971-112</i>
Violet Extension Cable, 9-inches (229 mm) long, yellow label (cable A)	51202329-710
Violet Extension Cable, 9-inches (229 mm) long, green label (cable B)	51202329-711
<i>Cable pair consisting of one each of the preceding two cables</i>	<i>51202329-712</i>

Ethernet cables

Ethernet cables are used in Series 8 cabinets to interconnect C300 Controller IOTAs. Only shielded twisted pair (STP) type cable is used. The use of unshielded twisted pair (UTP) cable is not allowed.

C300 Controller redundancy cable parts

One of the following Ethernet cables with orange end-boots is used to connect one C300 Controller IOTA to its partner C300 Controller IOTA in a redundant pair of C300 Controllers. The 36-inch (1 m) length cable is the default length used to interconnect partner IOTAs that are located vertically adjacent to each other on the same column of mounting plate. Other lengths are used when the partner IOTAs are not mounted close together.

Description	Model or Part Number
Ethernet Redundancy Cable, STP CAT5, orange boots, 36 inches (1 m) long	51305980-836
Ethernet Redundancy Cable, STP CAT5, orange boots, 48 (1.2 m) inches long	51305980-848
Ethernet Redundancy Cable, STP CAT5, orange boots, 60 (1.5 m) inches long	51305980-860
Ethernet Redundancy Cable, STP CAT5, orange boots, 84 inches (2 m) long	51305980-884

Other in-cabinet Ethernet cable parts

One of the following yellow-colored (FTEA) cables and one of the following green-colored (FTEB) Ethernet cables are used to connect a Control Firewall IOTA to a C300 Controller IOTA.

Description	Model or Part Number
<i>FTE Link A Cables</i>	
FTEA Ethernet Cable, STP CAT5, Yellow, 24 inches (610 mm) long	51305890-124
FTEA Ethernet Cable, STP CAT5, Yellow, 36 inches (1 m) long	51305890-136

6. Series 8 hardware configuration

6.11. Agency Approvals for Series 8 Cabinets

Description	Model or Part Number
FTEA Ethernet Cable, STP CAT5, Yellow, 48 inches (1.2 m) long	51305890-148
FTEA Ethernet Cable, STP CAT5, Yellow, 60 inches (1.5 m) long	51305890-160
FTEA Ethernet Cable, STP CAT5, Yellow, 84 inches (2 m) long	51305890-184
<i>FTE Link B Cables</i>	
FTEB Ethernet Cable, STP CAT5, Green, 24 inches (610 mm) long	51305890-224
FTEB Ethernet Cable, STP CAT5, Green, 36 inches (1 m) long	51305890-236
FTEB Ethernet Cable, STP CAT5, Green, 48 inches (1.2 m) long	51305890-248
FTEB Ethernet Cable, STP CAT5, Green, 60 inches (1.5 m) long	51305890-260
FTEB Ethernet Cable, STP CAT5, Green, 84 inches (2 m) long	51305890-284

6.11 Agency Approvals for Series 8 Cabinets

Agency approval labels can be applied to the cabinet by the Honeywell factory prior to but not after system shipment.

Inclusion of third-party products or Honeywell models not previously identified voids all agency approvals. The cabinet may only be labeled with a generic, no agency approval, Honeywell label.

6.12 Series 8 Hardware Attributes

Power draw and heat dissipation ratings for Series 8 components

The following table lists the power draw in amperes and heat dissipation in watts for the given Series 8 component model.

Model Number	Description	Current (Amps @ 24 Vdc)	Heat Dissipation (Watts)
<i>Series 8 I/O Modules and IOTAs</i>			
8C-PAIHA1	ANALOG INPUT with HART IOM	0.110	3.972

Model Number	Description	Current (Amps @ 24 Vdc)	Heat Dissipation (Watts)
8C-TAIXA1	ANALOG INPUT IOTA	0.320	2.464
8C-TAIXB1	ANALOG INPUT IOTA Redundant	0.320	2.464
8C-PAOHA1	Analog Output with HART IOM	0.205	8.492
8C-TAOXA1	ANALOG OUTPUT IOTA	0	0.606
8C-TAOXB1	ANALOG OUTPUT IOTA Redundant	0	0.606
8C-PDILA1	Digital Input 24VDC IOM	0.095	2.700
8C-TDILA1	DIGITAL INPUT 24VDC IOTA	0.190	4.220
8C-TDILB1	DIGITAL INPUT 24VDC IOTA Redundant	0.190	4.220
8C-PDODA1	Digital Output 24VDC IOM	0.105	5.680
8C-TDODA1	DIGITAL OUTPUT 24VDC IOTA	0	3.900
8C-TDODB1	DIGITAL OUTPUT 24VDC IOTA Redundant	0	3.900
8C-PAIMA1	TC/RTD IOM	0.120	
8C-TAIMA1	TC/RTD IOTA		
8C-PDIPA1	Digital Input Pulse Accumulation 24VDC IOM	0.105	

6.13 Series 8 Hardware Grounding Considerations

Grounding considerations in this section apply to Experion LX systems that include:

- C300 Controllers with Series 8 I/O

Grounding basics

Electrical systems must be connected to ground to:

- Protect personnel from electric shock,
- Protect equipment from damage,

6. Series 8 hardware configuration

6.13. Series 8 Hardware Grounding Considerations

- Protect site from lightning damage, and
- Insure the reliability and electrical integrity of the system.

To satisfy all of these requirements, a system may require multiple ground systems. A ground system is a series of rods driven into the earth or a grid system to connect to true earth. Building frames, equipment housings, instrument signals and lightning terminals are connected to these ground rods with appropriately sized wire.

Types of Grounding Systems

The following grounding systems are used for distributed control areas and are described in the following paragraphs.

- AC Safety Ground
- Supplementary Ground
- Master Reference Ground
- Lightning Ground

AC Safety Ground System (mains ground)

The safety ground protects the plant power system, electrical equipment, and personnel from electric shock. All metal equipment and enclosures are connected to this system through the ground wire. If insulated, the ground wire color is normally green. The ground wire and neutral wire are connected to the mains ground rods or grid located where the power enters the building or job area as shown in the following figure.

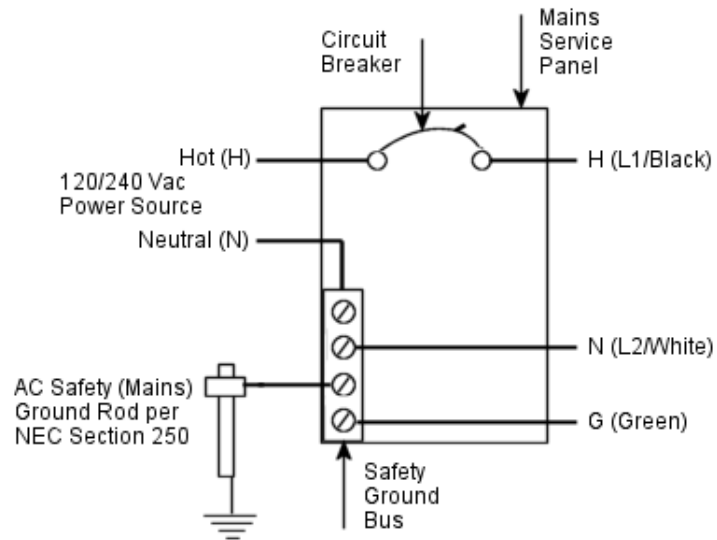

Figure 4 Typical AC power source through mains panel with safety ground bus and AC safety (mains) ground rod.

Supplementary Ground System

In accordance with NEC section 250.54, supplementary grounding electrodes can be used to connect to equipment grounding conductors. The supplementary ground can serve as the termination point for all common leads, as shown in the following illustration.

6. Series 8 hardware configuration
6.13. Series 8 Hardware Grounding Considerations

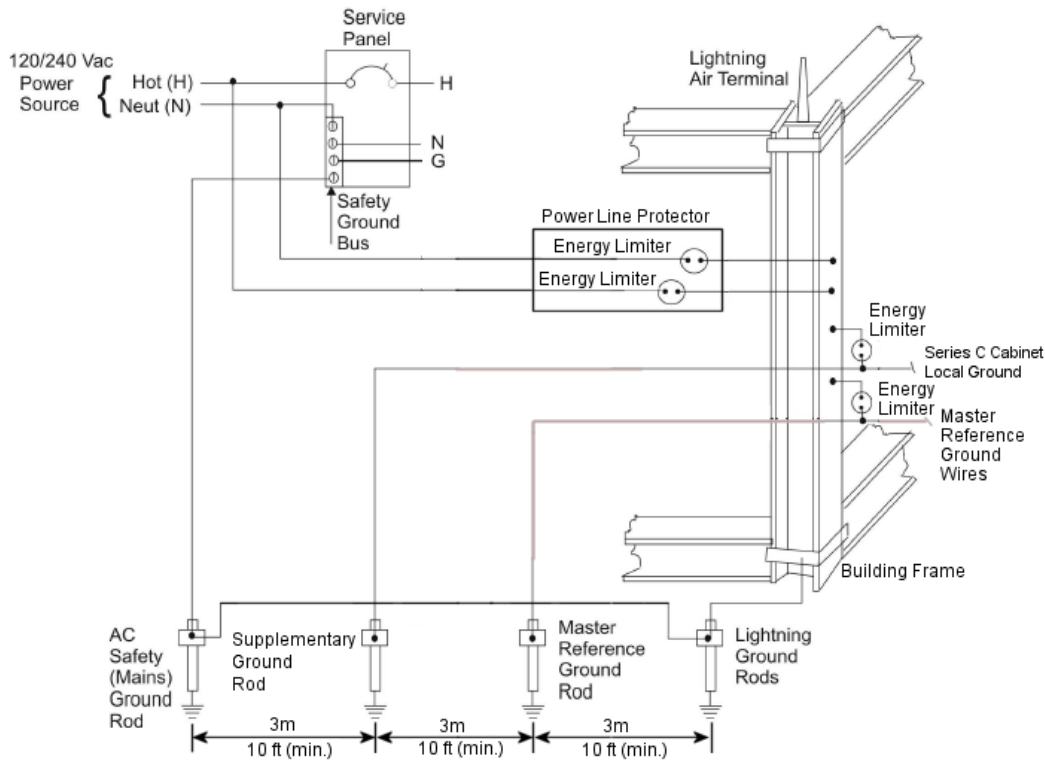

Figure 5 Typical AC power source through mains panel with safety ground bus, AC safety (mains) ground, supplementary ground, master reference ground, and lightning ground rods.

Lightning Ground System

The lightning ground system safely dissipates lightning energy to protect personnel and the structure. Lightning energy is intercepted by air terminals and/or the building frame and conducted through cable to the ground rods or grid. Lightning system ground rods are connected to mains ground rods (safety ground) to prevent arcing to the building, as shown in the previous figure.

Energy limiter for dissimilar grounds

Electrical codes do allow more than one grounding system, such as safety ground and master reference ground, in a building as long as there are devices which can automatically connect the two grounds together in case of a lightning strike or the

presence of a differential voltage greater than 90 volts. We recommend the use of a commercially available energy limiter device called a *Spark Gap*.

Isolation

Power line noise saturates the entire area around the safety (mains) ground rods. To prevent this noise from affecting the supplementary or master reference ground, separate it from the mains ground. The preferred arrangement is to install the mains ground and instrument grounds on opposite sides of the control area. If this is not practical, separate all ground rod systems by at least 3 meters (10 feet).

Codes and references

Ground rod systems must conform to local and national standards. Specific recommendations for design and installation of ground systems are contained in such technical publications as:

- NFPA - 70
- IEE - 142
- Manual on installation of Refinery Instruments and Control Systems: API RP 550
- Lightning Protection Institute Installation Code LPI-175

Two AC power sourcing methods

You can use one of the following methods to provide separate AC power sources for an Experion LX subsystem.

Method 1

This method uses an automatic transfer switch to provide two AC feeder sources. It does not require redundant power supplies or dual AC feeders because the transfer switch provides only one AC output. The automatic transfer switch can detect an AC failure and execute a transfer of its load from one service to another in 5 milliseconds. The Experion LX controller will perform without compromise even if this cycle requires 10 milliseconds.

Series 8 cabinet safety ground connections

The following illustration and callout table identify typical safety ground connections in the Series 8 cabinet. For Honeywell assembled cabinets, all power and ground connections within the cabinet are made by Honeywell manufacturing. The drawing is not to scale nor are component positions representative of actual mounting locations within the cabinet.

6. Series 8 hardware configuration
6.13. Series 8 Hardware Grounding Considerations



Figure 6 Typical safety ground connections in Series 8 cabinet

Table 1 Callout descriptions for Figure 37

Callout	Description
1	The AC safety ground bar is mounted to the cabinet frame.
2	To cabinet front or rear AC safety ground bar if required.
3	To cabinet complex front or rear AC safety ground bar as required.
7	To supplementary ground connection, if required.
8	The Local ground bar is mounted to the cabinet frame, if required.

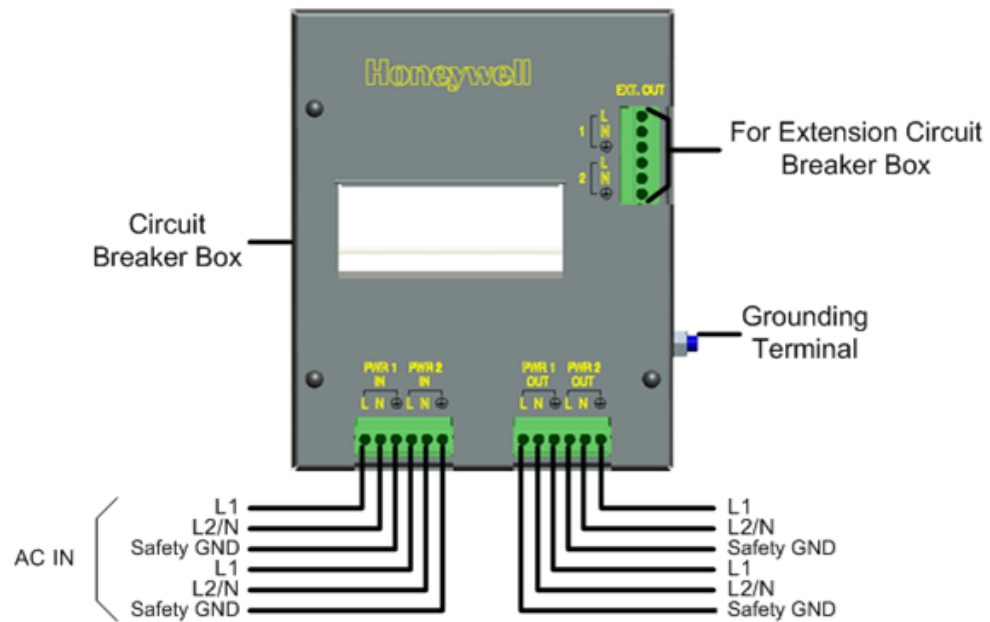

Figure 7 Typical power and ground connections to AC terminal block in Series 8 cabinet

7. Site Selection and Planning

7.1 Planning for General Considerations

Site selection is an important factor in planning and preparing for the installation of a Experion LX system. Issues that need to be addressed during the site planning are described below.

Location

Your Manufacturing Engineer is best suited to determine requirements such as cable length, routing, and shielding for these interconnections. Other guidelines include:

- Locate your equipment to obtain the best operating efficiency. Consider such things as proper lighting, noise, and proximity to related work areas.
- Consider accessibility of the site for delivery of equipment and supplies; and allow for access to service the equipment.
- Determine the need (if any) for remote termination panels.

Interim development location

Consider installing the Experion LX equipment in a quiet office environment (during the development phase of the installation) before implementing it on the factory floor, where it will have an impact on actual operations.

Facilities

The use of pre-existing facilities speeds installation, reducing costs. Whether the facility is existing or new, however, it must comply with the specifications (for example, safety, environmental, electrical, and other) described in this manual. Electrical power, grounding, air conditioning, and data communication requirements must all be addressed as part of the site preparation.

Insurance and zoning

Insurance costs may be affected by the type of building construction used and the location of system equipment (in relation to fire hazards and fire-fighting facilities). Zoning regulations may also affect installation plans and future expansion.

7.2 Planning for Environmental Considerations

In planning for the environmental conditions for electronic equipment, the following factors should be considered.

7. Site Selection and Planning

7.2. Planning for Environmental Considerations

Corrosion and dust

Consider both major (usually from process sources) and minor pollutants (often from nonprocess sources). Conformally coated assemblies are recommended for use in areas where corrosive vapors are present.

Fire prevention

Consult with the local fire-prevention authority to select fire extinguishers deemed suitable for electrical fires.

Lightning protection

A Lightning ground system safely dissipates lightning energy, protecting personnel, control system equipment, and the building. The ground system must conform to applicable codes and design construction criteria.

A good earth ground system minimizes the need for individual channel protection. However, if your facility is located in an area that has a history of severe lightning storms or if you have had a problem with lightning induced surges in the past with other instrumentation, you are probably aware of available surge protection devices. Properly sized surge protection devices incorporating solid state voltage limiters should be installed on power lines and all input/output wires associated with the system. You are responsible for evaluating your particular needs based on equipment location and the probability of a direct strike in the immediate area.

Temperature and humidity

The ambient temperature limits are specified in the Experion LX specifications. Relative humidity must be addressed, both in terms of magnitude and rate of change.

Ventilation and filtration

An air distribution system is recommended when atmospheric contaminants (from process fumes, road dust, or cooking fumes) are present. To protect the electronics from various fumes and contaminants, arrange an air flow moving towards the source and away from the electronics.

All air flow should be routed through a mechanical (non-electronic) dust filter. The mechanical filter should have a rating of not less than 20% after performing the Bureau of Standards discoloration test. The filter must meet all local fire codes.

Vibration

Flooring, desk tops, and shelves/mounting chassis must be stable and capable of supporting control system hardware in accordance with acceptable vibration levels (as specified in the Experion LX specifications).



ATTENTION

Consult your Honeywell Account Manager if any characteristics of your site do not meet the requirements specified in this or any other referenced manuals.

7.3 Planning for Power and Grounding

Compliance

Guidelines for complying with required electrical codes are listed below:

- All plant wiring (including power and signal cables) must be installed in accordance with the National Electrical Code (NEC), Canadian Electrical Code CEC), and all other local regulations.
- Power wiring must conform to the local electrical code. Use of a qualified contractor and approval by the local wiring inspector ensures compliance to this code
- Power wiring and signal cables installed by Honeywell (an optional service) will conform to the NEC or CEC. Upon your request, Honeywell will institute optional changes that will conform with the code, as well as adhere to local regulations and requirements.

Circuit capacities

Circuit capacity limits are governed by the NEC and CEC codes. Refer to these, and any other applicable local codes, to determine circuit capacities.

Outlet capacities

Outlet capacity limits are governed by the NEC and CEC codes. Refer to these, and any other applicable local codes, to determine outlet capacities.

Indicate the number and location of these outlets on your system layout drawing when designing your system. Outlets should be marked so that nothing, other than a system component, is plugged into them.

Multiple systems

Where multiple computer systems are installed, be sure to separate electrical power sources.

Convenience outlets

7. Site Selection and Planning

7.3. Planning for Power and Grounding



WARNING

All convenience outlets in the vicinity of this equipment must be grounded. The grounding conductors servicing these receptacles must be connected to earth ground at the service equipment, or at some other acceptable building earth ground (such as the building frame, in the case of a high-rise steel frame structure).

Supply separate and adequate convenience outlets in the Experion LX System area for items such as test equipment, vacuum cleaners, and floor buffers. To prevent noise interference from devices using these receptacles, convenience outlets must be on a circuit that has its transformer isolated from the circuits used for the system. One solution is to supply power for the components of the Experion LX System through an isolation transformer.

Honeywell products

Honeywell offers a line of regulators and power conditioners suitable for any system configuration. Consult your Honeywell Account Manager for further information.



REFERENCE

For detailed information on the power source requirements of the modules and computer systems used in your Experion LX System, refer to the Experion LX specifications.

General grounding guidelines



WARNING

The grounding system must be installed in accordance with the National Electrical Code (NEC), Canadian Electrical Code (CEC), and any other applicable electrical codes (to include: IEEE-142; Lightning Protection Institute Installation Code LPI-175; NFPA-78 (ANSI); IEEE Std. 142-1972).

A broken or high resistance safety ground creates a potentially lethal situation, especially in equipment that incorporates line filters. The line filters include appreciable line-to-chassis capacitance. As a result, if the green or green/yellow ground wire is not intact, a person touching the equipment and ground can receive a serious and possibly fatal shock.

Adequate grounding is important for safety considerations and for reducing electromagnetic noise interference. All earth-ground connections must be permanent and provide a continuous low impedance path to earth ground for induced noise currents and

fault currents. Refer to the following guidelines when considering the grounding requirements of your system:

- For safe operation of your equipment, a high-integrity grounding system must be installed as part of the building's wiring system.
- When providing the female receptacles or connectors, consider the following:
 - An equipment ground wire must be enclosed with the circuit conductors (phase and neutral wires),
 - The isolated ground wire must run directly from the outlet to the power source
 - The size of the ground conductor must be the same as, or larger, than the circuit conductors supplying the equipment
 - The ground conductor must be securely bonded to the building-ground electrode
 - Grounding provisions must be in accordance with the NEC, CEC, and any other local codes.

About Lightning Grounds

Lightning grounds must conform to applicable codes such as NFPA No. 78 (ANSI), IEEE Std. 142-1972, Code LPI-175, and other local codes. A typical lightning ground system consists of 10ft (3m) ground rods bonded (connected) to vertical structure members every 100ft (30m) along the building perimeter.

The mains ground is usually bonded to the lightning ground. Master reference grounds must be isolated from all other grounds. Where ground wires are close together in an enclosure, there is always the possibility for arcing (flashover) between ground wires when lightning strikes.

To inhibit this hazardous arcing, some codes require all ground wires to be connected through spark gap devices at the building perimeter. The following example shows the master reference (common) ground and the low-level shield grounds connected to a building vertical steel frame structure that is also connected to the lightning ground rod. Spark gap devices connect all ground wires to avoid an excess voltage difference that may be created by a lightning strike. We recommend 90 Volt, 150KA spark gaps for system grounds.

Lightning Ground Example (General Purpose Area)

7. Site Selection and Planning
7.4. Planning Your Cabling and Wiring

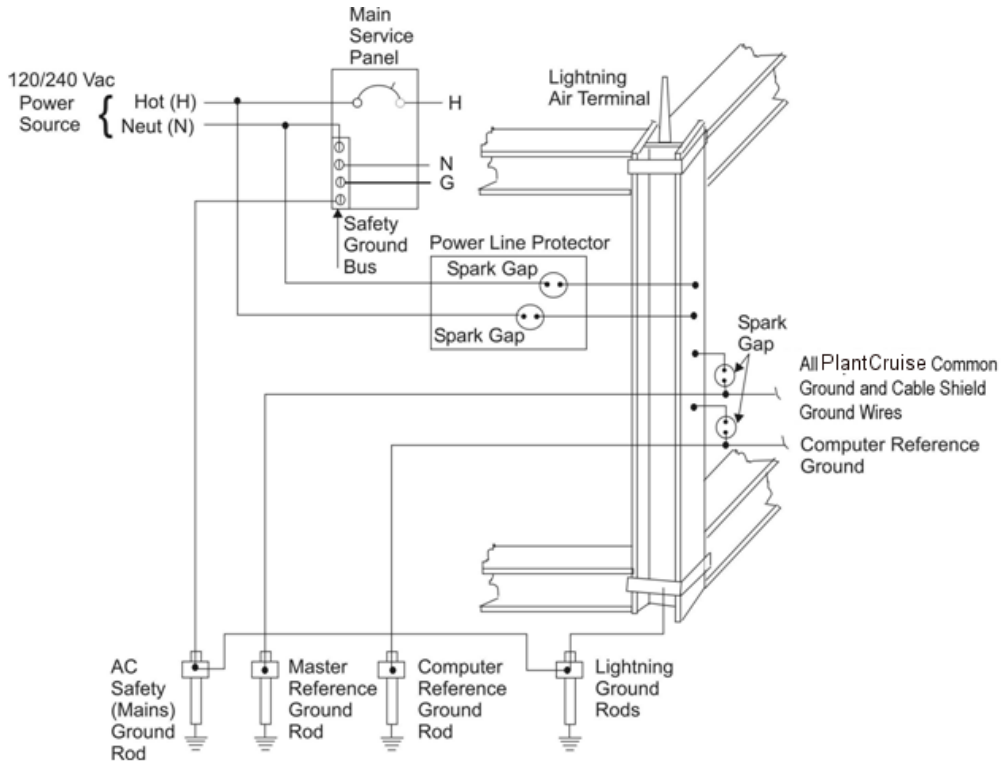

7.4 Planning Your Cabling and Wiring

Cabling and wiring

Table 10 describes procedures for cabling and wiring.

Table 2 Cabling/routing procedures

Step	Action
1	Determine physical installation and routing.
2	Consider cable type, cable distance, and redundant cable run paths.
3	Avoid installing cable through areas of high human traffic and high EMI/RFI.
4	Determine the maximum cable lengths and the number of drops.

7. Site Selection and Planning
7.4. Planning Your Cabling and Wiring

Step	Action
5	Prepare a wiring list.
6	Maintain a blueprint with location of wiring.
7	Plan for expansion.
8	Plan for diagnostics such as attachment spots for diagnostic tools (for example, a protocol analyzer).
9	Address separation issues for power, communications, and signal wiring/cabling.

7. Site Selection and Planning
7.4. Planning Your Cabling and Wiring

8. Planning to Minimize ESD/EMI

8.1 Introduction



ATTENTION

This section gives you general guidelines for reducing static discharge and establishing noise immunity within a Experion LX System. While these guidelines apply to the majority of installations, certain electrically harsh environments may require additional precautions.

Use these guidelines as a tool for helping avoid potential electrostatic discharge (ESD), electromagnetic interference (EMI) and transient EMI that could cause problems, such as adapter faults, chassis faults, communication faults, and so on. These guidelines are not intended to supersede local electrical codes.

8.2 Planning for Static Electricity Minimization

Ways to reduce electric static discharge

Static electricity can influence electronic equipment, and cause equipment malfunctions or damage. The effects may range from momentary "glitches" to outright failures, data loss, and intermittent failures that are difficult to locate and correct. The situation becomes even more acute with high-resistance materials, such as carpets and plastic seat covers, in work areas that are not environmentally controlled.

Devices and techniques that can be used to reduce electrostatic discharge include:

- an increase in the relative humidity - This may be practical in only relatively small, closed work areas.
- conductive overcovering for shoes
- antistatic floor surfaces - These floor surfaces have all the attributes of conventional floor surfaces, except they are conductive to suppress static electricity build-up.
- low-pile antistatic carpets - These carpets are conductive to suppress static electricity. Carpets are available in a wide variety of patterns and colors, can be placed over most existing floor surfaces and some carpets.
- antistatic grounded pads - These pads are for operator work station areas, and can be placed over most existing floor surfaces and carpets. They are meant primarily for the immediate vicinity of the work area, and require proper grounding.

8. Planning to Minimize ESD/EMI

8.3. Planning for Interference Minimization

- avoiding synthetic materials - Avoid linoleum and synthetic carpets, and other materials that generate static. If such floor coverings are already in place, antistatic mats can be installed on the floor near the terminals.

8.3 Planning for Interference Minimization

General considerations

Before deciding on an installation site, a planning review should be conducted to assess the environment and to determine any special product considerations or installation needs that may be necessary to ensure normal system operation and product protection.

Magnetic interference

Strong magnetic fields generated by some industrial machinery can cause malfunction of electronic equipment and magnetic storage media in shop-located devices. Avoid installing the Experion LX computer equipment close to sources of magnetic disturbance.

Electromagnetic and radio frequency interference

In some situations, the proposed site may experience electromagnetic interference (EMI) or radio frequency interference (RFI). These interference's can result from nearby radio-frequency sources (for example, two-way radios, TV, or radio transmitters) or industrial equipment (such as arc welders, fluorescent lights, or electronic air cleaners). Sources of EMI include electric floor heaters, transformers, and rotating machinery (such as fans or drills) and power distribution lines.

The effects of RFI and EMI can be reduced or eliminated by properly shielding and grounding the cables, and by routing the cables away from potential interference sources.

8.4 Planning for Power Distribution

Transformer connections

You can minimize noise induced by the power-distribution system by connecting the power supply directly to the secondary of a transformer as shown in the following two figures. The transformer provides dc isolation from other equipment not connected to that transformer secondary.

Connect the transformer primary to the ac source. Connect the high side of the transformer secondary to the L1 terminal of the power supply; connect the low side of the transformer secondary to the neutral (common) terminal of the power supply.



ATTENTION

Three EMI minimization techniques utilized in the following two figures include:

- Connection of a suppressor across an inductive load (such as the CRM coil).
- Inclusion of a second transformer providing power to the input circuits and power supplies, and isolating them from the output circuits.
- Connection of a suppressor to minimize the EMI generation from the net inductive load switched by the CRM contacts.

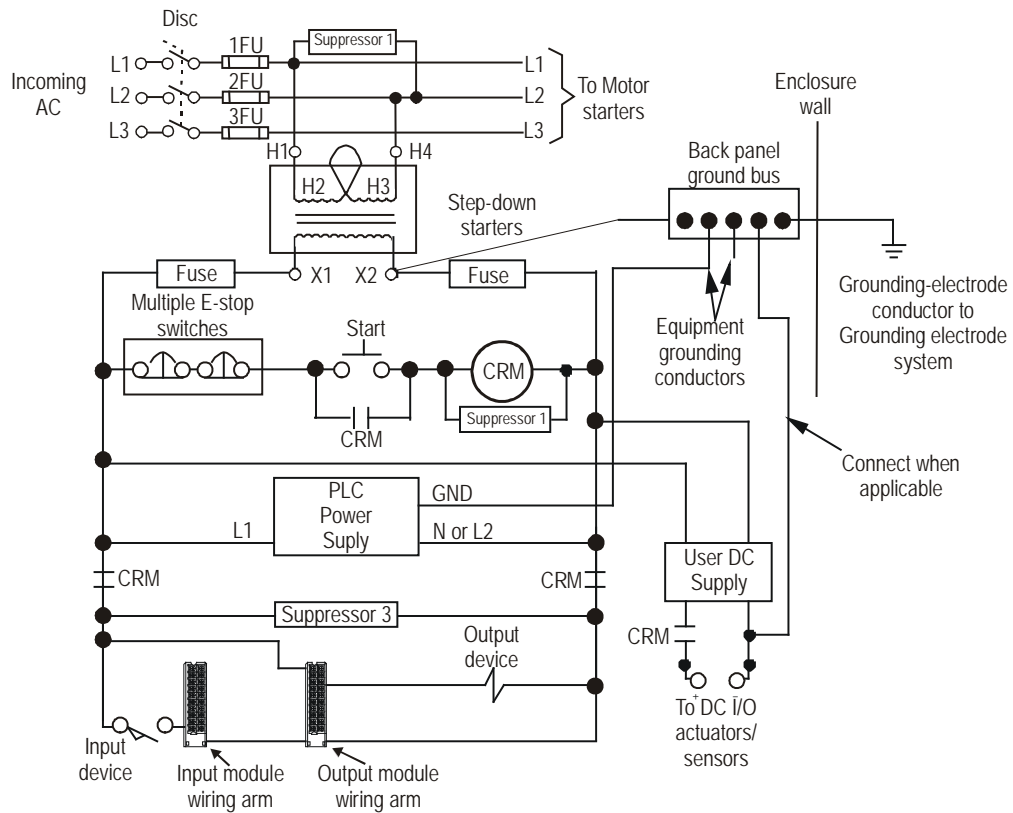

8. Planning to Minimize ESD/EMI
8.4. Planning for Power Distribution

Grounded ac power distribution system with master-control relay

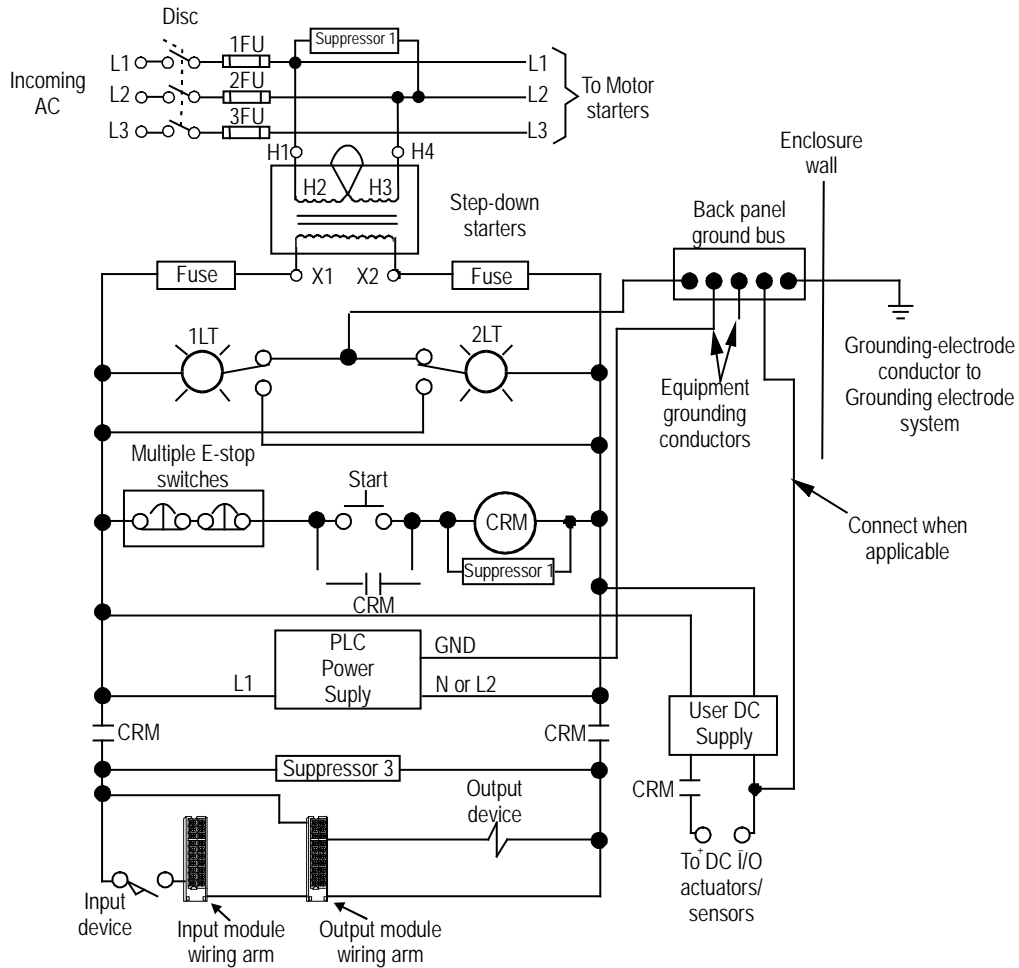

Ungrounded ac power distribution system with master-control relay

Monitoring the master control relay

The master-control relay can be monitored in your control applications, in order to hold all outputs off anytime its contacts are open. To do this, connect one input directly to the L1 side of the line, on the load side of the CRM contacts as shown in the previous figure and the following figure. In the control application, this input is used to hold off all outputs, anytime the CRM contacts are open.

If you fail to do this, closing the CRM contacts could generate transient EMI because outputs are already activated. To have outputs turned on when CRM contacts are closing, would be analogous to squeezing the trigger on a hand-power tool as you're plugging it in the electrical outlet.

Sizing the transformer

To determine the required rating of the transformer, add the external-transformer load of the power supply and all other power requirements (input circuits, output circuits). The power requirements must take into consideration the surge currents of devices controlled by the processor. Choose a transformer with the closest standard transformer rating above the calculated requirements.



ATTENTION

Each power supply with under-voltage shut-down protection generates a shut-down signal on the backplane, whenever the ac line voltage drops below its lower voltage limit. The power supply removes the shut-down signal whenever the line voltage comes back above the lower voltage limit. This shut-down is to guard against invalid data being stored in memory.

Because a capacitive-input power supply converting ac to dc draws power only from the peak of the ac voltage waveform, the external transformer load (in VA) of each power supply is 2.5 times its real power dissipation (in Watts). If the transformer is too small, the peaks of the sine wave are clipped. Even if the voltage is still above the lower voltage limit, the power supply senses the clipped wave as low voltage and sends the shut-down signal.

Transformer separation of power supplies and circuits

Experion LX power supplies have circuits that suppress electromagnetic interference from other equipment. However, you should isolate output circuits from both power supplies and input circuits, this will help prevent output transients from being induced into inputs and power supplies. In many applications, power is provided to the input circuits and power supplies through a separate transformer as shown in the following figure.

8. Planning to Minimize ESD/EMI

8.4. Planning for Power Distribution

Refer to *Isolation transformers* and *Constant-voltage transformers* in this document, for information about the use of additional transformers.

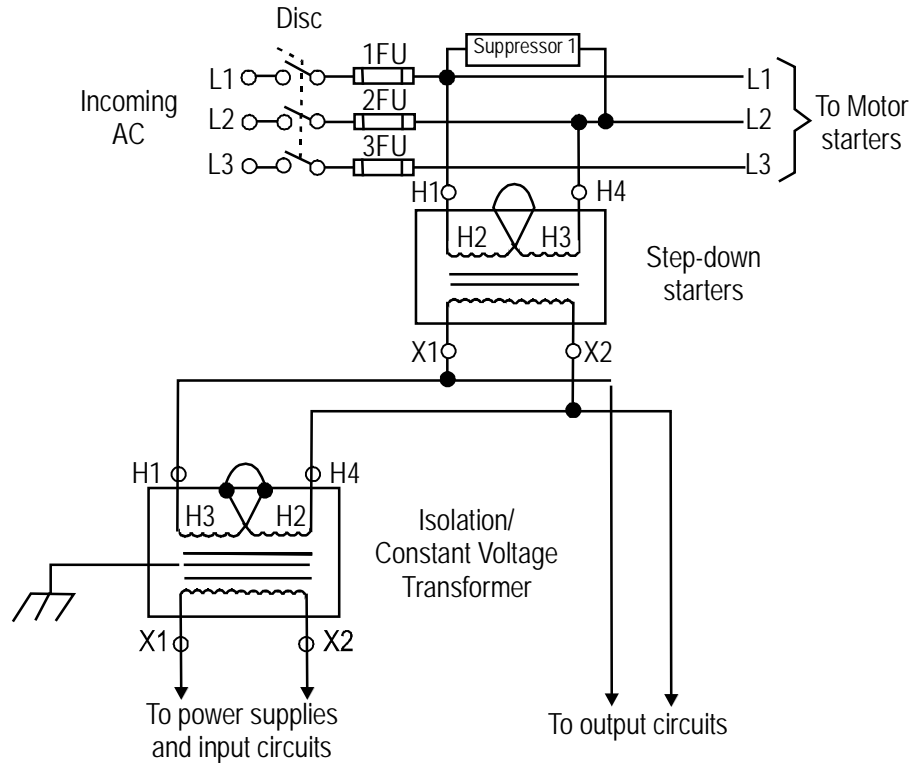

Second transformer in a power distribution system



ATTENTION

To minimize transient EMI generation when power is interrupted by the interrupt switch, connect a suppressor across the primary of the transformer (as shown in the figure above).

Isolation transformers

For applications near excessive electrical noise generators, an isolation transformer (for the separate transformer) provides further suppression of electromagnetic interference

from other equipment. The output actuators being controlled should draw power from the same ac source as the isolation transformer, but not from the secondary of the isolation transformer.

Constant-voltage transformers

In applications where the ac power source is especially "soft" and subject to unusual variations, a constant-voltage transformer can stabilize the ac power source to the processor and minimize shutdowns. The constant-voltage transformer must be of the harmonic neutralizing type.

If the power supply receives its ac power through:

- constant-voltage transformer, the input sensors connected to the I/O chassis should also receive their ac power from the same constant-voltage transformer.
- another transformer, the ac source voltage could go low enough that erroneous input data enters memory while the constant-voltage transformer prevents the power supply from shutting down the processor.

The output actuators being controlled should draw power from the same ac sources as the constant-voltage transformer, but not from the secondary of the constant-voltage transformer (See the previous figure).

Transformer ground connections

When ac power is supplied as a separately derived system through an isolation/step-down transformer, you can connect it as a grounded ac system or an ungrounded ac system. For a grounded ac system, connect one side of the transformer secondary to the ground bus. For an ungrounded ac system, connect one side of each test switch for the ground-fault-detector lights to the ground bus. We do not recommend an ungrounded system. Follow local codes in determining whether to use a grounded system.

When bringing ac power into the enclosure, do not ground its raceway to the ground bus on the back-panel. Connecting the raceway to the ground bus may cause the processor to fault by introducing EMI into the grounding circuit. Local codes may provide an exception for permitting isolation from the raceway. For example, article 250-75 of the National Electrical Code has an exception that explains the conditions under which this isolation from the raceway is permitted.

8.5 Suppressing Power Surges

Why do they occur?

Transient electromagnetic interference (EMI) can be generated whenever inductive loads (such as relays, solenoids, motor starters, or motors) are operated by hard contacts (such as pushbutton or selector switches). The wiring guidelines are based on the assumption that you guard your system against the effects of transient EMI by using surge-suppressors; these will suppress transient EMI at its source. Inductive loads switched by solid-state output devices alone do not require surge-suppression. However, inductive loads of ac output modules (that are in series or parallel with hard contacts) require surge-suppression to protect the module output circuits as well as to suppress transient EMI.

Surge-suppressors

Surge-suppressors are usually most effective when connected at the inductive loads. They are still usable when connected at the switching devices; however, this may be less effective, because the wires connecting the switching devices to the inductive loads act as antennas that radiate EMI. You can see the effectiveness of a particular suppressor by using an oscilloscope to observe the voltage waveform on the line.

Ferrite beads

Ferrite beads can provide additional suppression of transient EMI. Fair-Rite Products Corporation manufactures a ferrite bead (part number 2643626502) which can be slipped over Category-2 and Category-3 conductors. You can secure them with heat-shrink tubing or tie-wraps. With a ferrite bead located near the end of a cable (or cable segment in the case of a daisy-chain or dropline configuration), transient EMI induced onto the cable can be suppressed by the bead before it enters the equipment connected to the end of the cable.

Typical suppression circuitry

The following shows typical suppression circuitry for different types of loads.

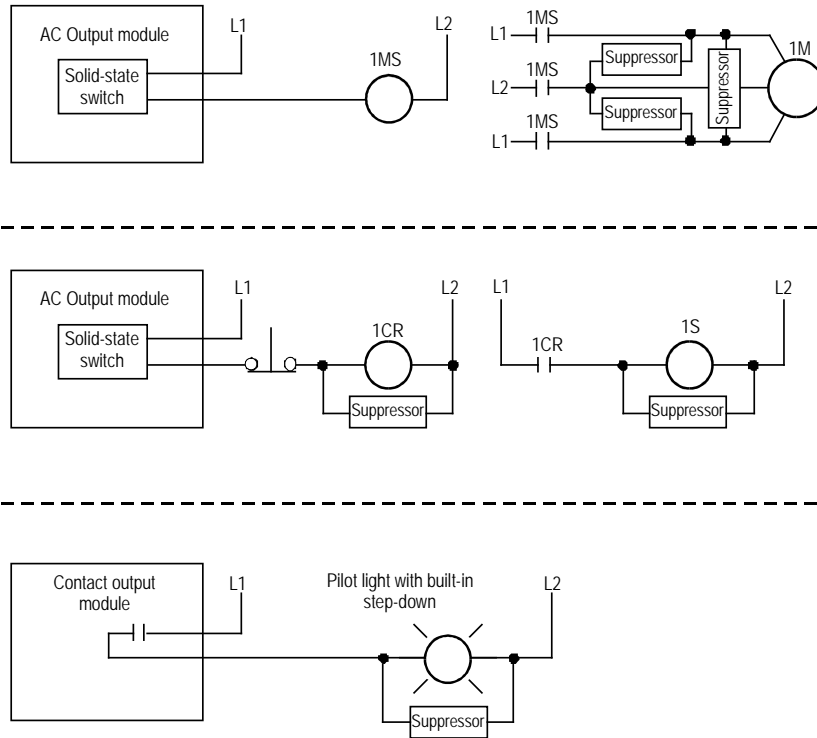

Examples

The following figure shows three examples of where to use suppressors.

- In example 1, although the motor starter-coil is an inductive load, it does not need a suppressor; this is because it is switched by a solid-state device alone.
- In example 2, the relay coil needs a suppressor, because a hard-contact switch is in series with the solid-state switch. However, in both examples 1 and 2, we show a suppressor on the motor and solenoid, because it is an inductive load switched by the hard contacts of the motor starter or relay. Even if they have no interaction with the control system, regularly cycled loads of this type need suppression, if conductors connecting to these loads are:
 - connected to the same separately derived system as that of the control system, or
 - routed near the control system conductors, as per the routing guidelines

8. Planning to Minimize ESD/EMI

8.6. Planning Enclosure Lighting

- In example 3, the pilot light has a built-in step-down transformer that needs a suppressor because it is an inductive load being switched by the hard contacts of a contact output module; without suppression, the transient EMI would be generated inside the I/O chassis. Lights with built-in step-down transformers that are switched by hard contacts may not need to be suppressed, because the noise spike they can generate may be only approximately one tenth that of a relay or motor starter.

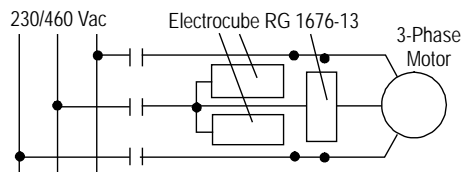

For 3-phase apparatus a suppressor is needed across each phase.

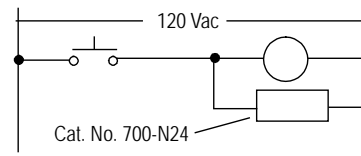

For small apparatus (relays, solenoids, and motor starters up to size 1)

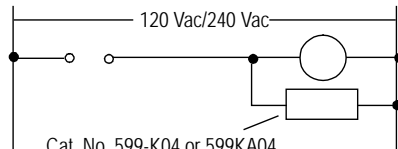

Cat. No. 599-K04 or 599KA04 or ITW Paktron 104M06QC100

For large apparatus (contacts up to size 5).

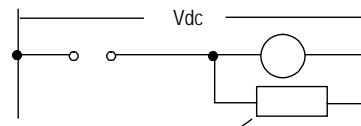

700-Nx
For dc relays.



ATTENTION

In all cases, the ac power coming into the I/O modules must be switched by the CRM contacts. Therefore, a suppressor is needed across the line at the load side of the CRM contacts. The application (voltage, net load of I/O circuits) dictates the specific suppressor needed across the line at the load side of the CRM contacts.

8.6 Planning Enclosure Lighting

Minimizing fluorescent lamp interference

Fluorescent lamps are also sources of EMI. If you must use fluorescent lamps inside an enclosure, the following precautions may help guard against EMI problems, as shown in the following figure:

- Install a shielding grid over the lamp.

- Use shielded cable between the lamp and its switch.
- Use a metal-encased switch.
- Install a filter between the switch and the power line, or shield the power-line cable.
- Do not use dimmers.

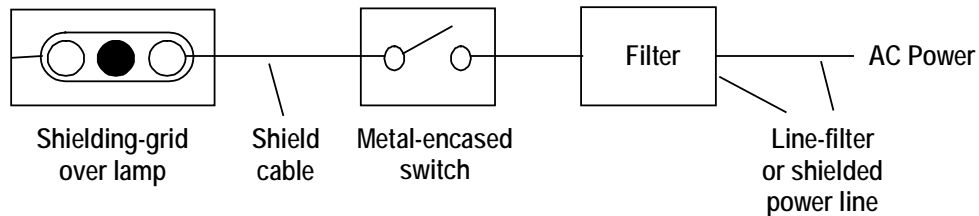

8.7 Avoiding Unintentional Momentary Turn-on of Outputs

Minimizing the probability



WARNING

Unintentional turn-on of outputs as the power source is connected or disconnected (even if momentary) can result in injury to personnel as well as damage to equipment. The danger is greater with fast-response actuators.

You can help minimize the probability of unintentional momentary turn-on of ac and dc circuits by following each of these guidelines according to your specific application:

- Follow the surge-suppression guidelines in this document.
- Follow the bonding and grounding guidelines in this document.
- Do not unnecessarily disconnect the power source from output circuits.
- Where possible, turn off all outputs before using CRM contacts to interrupt the output circuit power source.

8. Planning to Minimize ESD/EMI

8.7. Avoiding Unintentional Momentary Turn-on of Outputs

- Hold off all outputs anytime the CRM contacts are open to be certain that they are off as power is reconnected.

Minimizing the effect

Even if unintentional momentary turn-on does occur, the effects can be minimized if:

- actuators have a home position, which is, defined by a spring return.
- (for latching actuators in the ladder logic), you use non-retentive energize Logic Function Blocks with hold-in (seal-in) paths to maintain the established position, until power turnoff. Leave outputs off initially at power turn-on.
- each input or other load device connected to an output has an input-filter time-constant no lower than necessary for the application.

Testing the minimization

After designing and installing your system following these guidelines to minimize unintentional momentary turn-on and any effects thereof, test the system by de-energizing, and re-energizing the CRM relay.

9. Control Processing Considerations

9.1 Control Processor Load Performance

Background

The Control Processor provides a very flexible execution environment for performing all types of control at different execution speeds. To determine how much control can be performed by a Processor, Processor Usage and Memory Usage are considered. The number of modules or blocks a Control Processor can execute is determined by available CPU and memory resources. Other constraints, such as total number of CMs and SCMs, must also be taken into account.

Load performance calculation example

The following table represents an example control strategy configuration (not necessarily typical) calculations to determine control processor load performance.



REFERENCE

For detailed information regarding processing units and memory units, refer to the Experion LX specifications.

The Experion LX specifications can be found on the Honeywell website: <http://www.acs.honeywell.com/>. Just follow the Experion LX product links.

Table 3 Control Processor load performance calculation example

Module Type	No. of Modules	Period, sec	Module PU	Module MU	Total PUs ¹	Total MUs
Analog Data Acquisition CM	10	1	4	9	40	90
Regulatory Control CM	40	0.5	2	4	160	160
Auxiliary Function CM	5	0.5	8	18	80	90
Digital Data Acquisition CM	20	0.1	1	3	200	60
Device Control CM	100	0.1	1	3	1000	300
Logic Control CM	10	0.1	1	3	100	30

9. Control Processing Considerations

9.1. Control Processor Load Performance

Module Type	No. of Modules	Period, sec	Module PU	Module MU	Total PUs ¹	Total MUs
Sequence Control Module (SCM)	4	0.1	2	90	80	360
Sequence Control Module (SCM)	32	1	2	90	64	2880
				Total	1724	3970
				Max	2000	4000
<p>PU = Processing Unit per Control Cycle; MU = Memory Unit, Kbytes PUs for any given CM = (PU per Cycle) / (Cycle Time, sec.)</p> <p>Available Period for all CM and SCM types are 0.05, 0.1, 0.2, 0.5, 1.0 and 2.0 sec.</p> <p>a) ¹ Total PUs = (No. of Modules) x (Module PU) / (Period, sec.) for each CM type.</p>						

10. Application Licensing Considerations

10.1 Licensing Overview

When the user tries to launch an Engineering Tool (for example, Control Builder), the license availability is checked and the tool is launched only if license is available. If the number of specific Engineering Tool applications exceeds the maximum number permitted, then an error will be reported to the user and an error message will be logged into the Engineering Tools error log.

<Error Message><Description>

For Example,

PS_E_<Application Name>LAUNCHLICLIMITERROR <Application Name> cannot be launched. Maximum Licensed number <Number> exceeded.

Licensing will be checked when:	Possible result:
<ul style="list-style-type: none">• Launching Control Builder	<ul style="list-style-type: none">• Error
<ul style="list-style-type: none">• Configuring Function Blocks	<ul style="list-style-type: none">• Warning
<ul style="list-style-type: none">• Loading Function Blocks	<ul style="list-style-type: none">• Error

10.2 Viewing Licenses

- To view licenses in Control Builder, select Tools -> License Display.
 - Features section: This section contains license information for Experion LX Engineering Tool Options that are not related to template libraries or individual template usage.
 - Libraries section: This section indicates the set of libraries that a user has licensed. If a library is licensed, all the templates in the library are available to the user. If the name of a library option is grayed out, the option is not enabled for the Experion LX System.
 - Templates section: This section indicates the set of options for Experion LX system templates that a user has licensed. Some user templates may be licensed for "unlimited" use, while others have usage limits. If the system template license option is limited, the user may configure as many instances as they like, however, the maximum number of instances that may be simultaneously loaded in the

10. Application Licensing Considerations

10.3. License Validation

system is indicated by the contents of the Limit column. To help the user manage the use of limit licensed system templates, the Configured column indicates the number of instances that the user has configured, and the Loaded column indicates the number loaded.

- If a template option is "grayed", it is not licensed for use in the system, and the Limit, Configured, and Loaded columns will be empty.

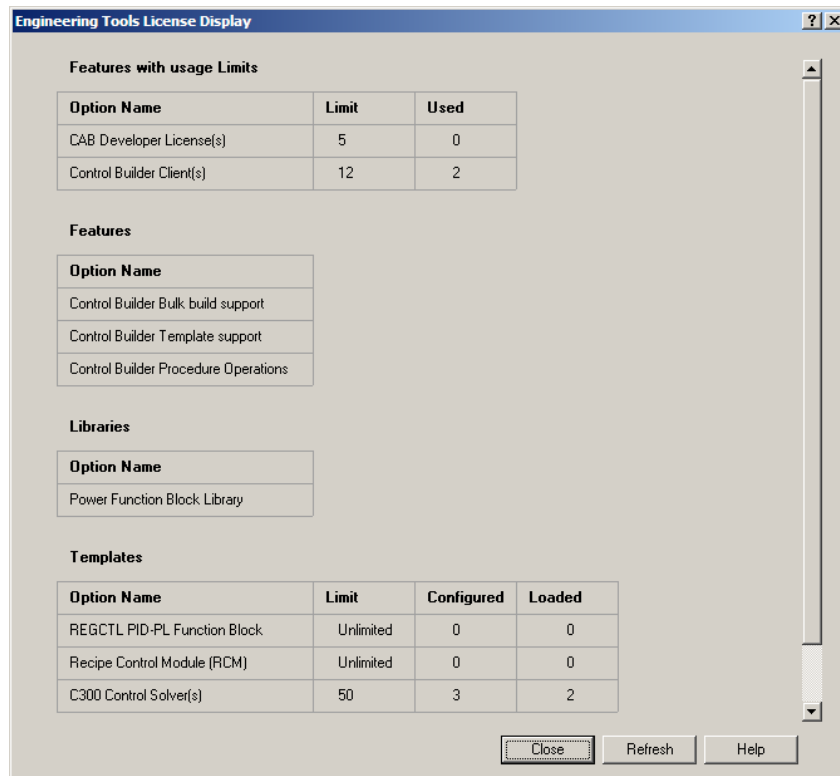

- To view licenses in Station, select Configure -> Server License Details. Select the Engineering Tools tab.
 - All purchased options appear with a green indicator, with all other options in black.
 - If the option is a countable option (Fixed Number and Enum options), the display indicates how many instances are purchased, and how many are used. For

example, if 20 instances of a particular template are purchased, and only 8 used, the display will indicate both.

10.3 License Validation

Licensing at Configuration time

During Configuration, users are allowed to configure the blocks irrespective of the license purchased. Warnings will be generated only when the chart is closed. The user will be allowed to continue or cancel the configuration. Basic Block warnings will be generated when the chart is closed. Warnings for tagged objects are generated at Instantiation time. Warnings will be logged into the Engineering Tools error log, using standard error reporting interfaces.

The Warning Dialog is given below,

<Warning Message> < Description >
For Example, PS_E_<ET Name>_<FB Name. Member name>LICLIMITWARNING <FB name> configuration exceeded the maximum licensed limit <number>

Licensing at Load time

During load time, an error message will be displayed if a block load is attempted that exceeds the licensed capabilities. The function block will not be loaded, and the error will also be logged to the Engineering Tools error log, using standard error reporting interfaces.

The Error Dialog is given below,

<Error Message> < Description >
For Example, PS_E_<ET Name><Template Name>LOADFAILERROR <FB name.membername> Load exceeded the maximum licensed limit <number> PS_E_<ETName>BLKLOADFAIL <FB Name> Load failed.

There are three ways of loading a function block:

Load from Project:	License checks will be applied.
--------------------	---------------------------------

10. Application Licensing Considerations

10.4. Online License Change

Load from Snapshot:	License checks will not be applied.
Load from Monitoring:	License checks will not be applied.

Multiple Block Load scenario

In case of multiple block load scenarios, where the user loads more than one block at a time, the load can continue even if there is an error. The blocks exceeding the licensed capabilities will not be loaded, and all other blocks will be loaded to the controller. An Error will be reported and logged to the error log indicating the blocks not loaded.

Attempting to launch an Engineering Tool when the license limit is reached

The license availability is checked and an error is reported to the user that the number of simultaneous applications exceeded the licensed number. The severity will be indicated by a stop icon in the error message box. The user will not be able to launch that application and an error message will be logged into the Experion LX Engineering tools error log.

Handling Application failures

Whenever a new application is launched, an attempt will be made to communicate with the other instances of the tool to ensure that they are still running. If there is a communication failure or communication time out due to crashing of any of the application, that particular application will not be included in license checks.

Maintaining Licensing Information

License information is refreshed upon SR Service startup.

10.4 Online License Change

If the user applies for a new license online and tries to use the modified license, the tool does not need to be restarted to access the new license information. SR queries the license key directly whenever the clients want to access the license information and there is no caching of license information.

11. Appendix A

11.1 Corrosion Protection Planning

Conformal coating versus corrosion

Corrosion is one of the leading causes of electronic printed circuit assembly board failure in harsh environments. One method used to protect printed circuit boards used in harsh environments is to conformally coat them with a thin layer of a special plastic material. The conformal coating is resistant to the corrosive effects of humidity and most chemical gases to extend the life of the printed circuit assemblies.

The following table recommends the minimum equipment requirement that is based on environmental classification tests at the site where the equipment is installed.

Environment Classification Minimum	Equipment Requirement
Mild (G1)	No conformal coating
Moderate (G2)	Conformal coating
Harsh (G3)	Conformal coating
Severe (Gx)	Conformal coating and installation in an environmentally hardened enclosure

G3 rating

All coated assemblies will withstand the effects of a G3 (harsh) rated environment. Uncoated boards are rated for mild (G1) environments. A harsh environment is defined by ANSI/ISA-S71.04-1985, "Environmental Conditions for Process Measurement and Control Systems: Airborne Contaminates."

The following table defines environmental harshness levels for airborne contaminants as defined by ANSI/ISA-S71.04-1985.

Severity Level	G1 (Mild)	G2 (Moderate)	G3 (Harsh)	Gx (Severe)
Copper Reactivity Level (Angstroms/Month)	Less than 300	Less than 1000	Less than 2000	Greater than or equal to 2000
Contaminant Gas	Concentration (Parts/Billion)			

11. Appendix A
11.1. Corrosion Protection Planning

Severity Level	G1 (Mild)	G2 (Moderate)	G3 (Harsh)	Gx (Severe)
Group A H ₂ S	Less than 3	Less than 10	Less than 50	Greater than or equal to 50
SO ₂ , SO ₃	Less than 10	Less than 100	Less than 300	Greater than or equal to 300
Cl ₂	Less than 1	Less than 2	Less than 10	Greater than or equal to 10
NO _x	Less than 50	Less than 125	Less than 1250	Greater than or equal to 1250
Group B HF	Less than 1	Less than 2	Less than 10	Greater than or equal to 10
NH ₃	Less than 500	Less than 10,000	Less than 25,000	Greater than or equal to 25,000
O ₃	Less than 2	Less than 25	Less than 100	Greater than or equal to 100

Gas concentrations

Gas concentrations are for reference purposes only and are believed to approximate the reactivity levels, assuming relative humidity is less than 50 percent. For each 10 percent increase in relative humidity above 50 percent, or change in relative humidity by greater than 6 percent/hour, the severity level can be expected to increase by one.

Harsh Environment Enclosure

If the IOPs must be located in a severe environment, Honeywell offers a harsh environment enclosure that is capable of withstanding a Gx rated atmosphere. This enclosure features a sealed NEMA 4x stainless steel cabinet, a special 7-Slot card file with fans for air circulation to house conformally coated IOP and I/O Link Extender cards, and a 24 Vdc Power System that uses components found in the AC Only Power System. There is no active external cooling required for external ambient temperatures of

Honeywell

Honeywell Process Solutions
1860 W. Rose Garden Lane
Phoenix, AZ 85027 USA