



A universal transmitter for toxic, oxygen and combustible gas detection compatible with all Honeywell gas sensing technologies

XNX Universal Transmitter



Universal Gas Sensing Platform



High performance

- Flammable gas detection 0 to 100% LFL/LEL
- Point IR with heated optics provides immunity to poisoning and no hidden faults
- Open-path IR flammable gas detection in LEL-m measurement
- Electrochemical cell offers toxic gas detection in ppm
- IR cell provides CO₂ and combustible gas monitoring
- Robust and reliable operation in explosive areas and harsh environments

Flexible Operation

- 3 versions - supports mV (Catalytic Bead and IR Cell), Electrochemical Cell and IR (point and open-path) gas detection
- Multi-Purpose Detector (MPD) with field serviceable mV, Catalytic bead and IR Cell capability
- 4-20mA with HART® as standard
- Multiple communications options include up to 3 relays, MODBUS® and FOUNDATION® H1 Fieldbus (pending)
- Optional local IS port for handheld HART configurator

Easy to Use

- Large, backlit, easy-to-view LCD display offers multi-sensory indicators (visual icons, colored buttons, text, etc.) to display gas and sensor readings
- User interface supported by 8 selectable languages (English, Spanish, German, Italian, Portuguese, French, Russian, Chinese)
- Self-test and fault indication features
- Non-intrusive, one-man operation
- Quick calibration with auto-inhibit

Easy to Install

- 3 or 4 wire operation, source, sink or isolated
- Use with conduit or cable installations
- Simple plug-in sensors and replaceable cells
- NEMA 4X IP66 rated for rugged indoor/outdoor use

Cost Effective

- Minimal training required
- One-man operation
- Plug-in sensor replacement
- All necessary accessories included

Applications

- Offshore Oil & Gas production platforms
- Onshore Oil terminals
- Refineries
- Gas Transmission
- Gas Distribution
- LNG terminals
- Gas storage terminals
- Chemical plants
- Petrochemical plants
- Solvent recovery operations

The XNX Universal Transmitter marks a new turn in gas detection from Honeywell Analytics. It supports the widest range of sensors on a common platform and offers a modular choice of inputs and outputs.



Bringing together the best solutions in gas detection

Electrochemical

- Proven electrochemical sensing technology
- Surecell™ electrochemical cells are ideal for hot and humid environments
- Long life sensing cells (typical >2 years)
- Patented 'Reflex' sensing element verification diagnostics
- Sensor recognition software auto configures transmitter
- Plug and play factory configured sensors
- Intrinsically safe sensor connection permits hot swap, reducing down time

Catalytic Bead

- Supports Honeywell Analytics 705, 705HT, Sensepoint, Sensepoint HT and MPD sensors
- Fast response to wide range of hydrocarbons and flammables

Infrared (Open Path IR, Point IR, IR Cell)









- Supports Honeywell Analytics Searchline Excel, Searchpoint Optima Plus
- Failsafe operation
- Fast speed of response
- Reduced routine maintenance
- Immune to catalytic poisons
- Long operating life
- Works in inert atmospheres

XNX is designed for flexible integration, simple installation, user friendly operation and straightforward maintenance. It is ideal for use with a range of gas monitoring controllers or industry standard PLCs. Users are assured of being protected in all conditions with Honeywell Analytics gas monitoring solutions.

XNX's modular design enables Honeywell Analytics to offer appropriate, cost effective solutions to a wide range of gas detection requirements.

With the XNX, you are freed from the need to add extra controllers, junction boxes, relays, monitors and other equipment accessories.

The XNX Universal Transmitter is an excellent choice for those who want a total integrated monitoring and safety solution for an industrial plant.

XNX Technology Enablers			
Catalytic Bead	IR Cell	Electrochemical	Infrared
 705/705HT  Sensepoint HT  MPD Catalytic Bead  Sensepoint	 MPD IR CELL	 ECC Sensors	 Optima (Point IR)  Searchline Excel (Open)
mV		EC	IR
XNX Universal Platform			

Photos not to scale.

Communications

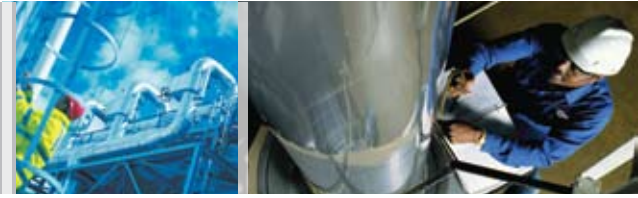

Installation Details



The XNX's powerful advanced communications module adds increased functionality and flexibility to a gas detection network. Standard HART communications, along with optional Modbus, Foundation Fieldbus (pending) or relays, interface with a PLC and a host of other protocol compatible devices found in industrial applications.

Back-lit, easy-to-read LCD display with icons includes a broad range of language options including English, Spanish, French, Italian, Portuguese, German, Russian and Chinese to meet global requirements.

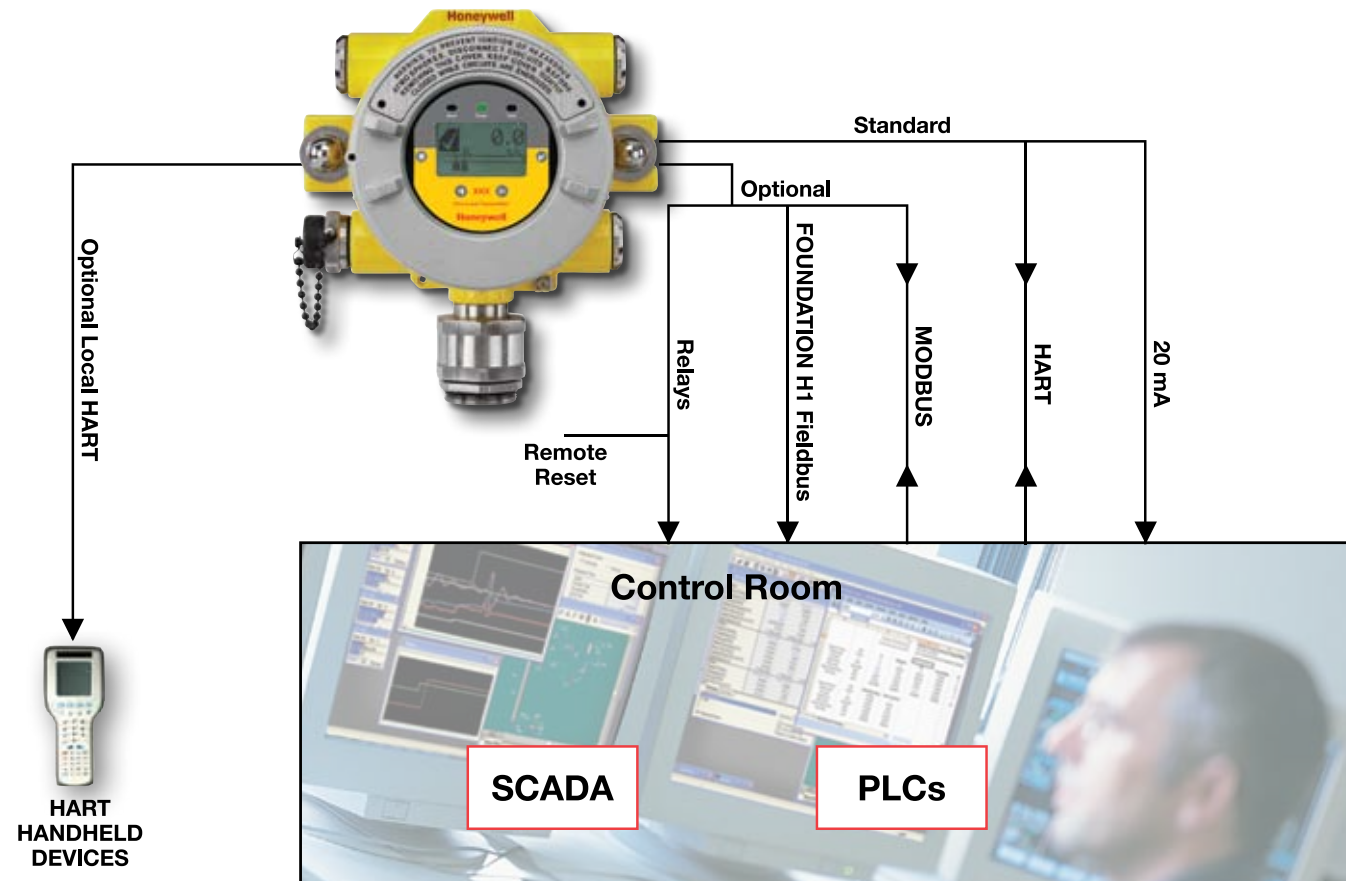

Mechanical

The XNX enclosure is available in a painted stainless steel or aluminum housing with a marine grade coating. Five threaded conduits/cable entries are available in Metric or NPT versions, and ruggedized mounting options provide ultimate installation flexibility. Instrumentation built on various sensing technologies can be attached locally to the transmitter or remotely with the appropriate

accessories. Inside, customer and sensor connections to the unit are designed to protect against dangerous electrical misconnections. With pending approvals to UL, CSA and ATEX requirements for Hazardous Locations, and IP66/67 rating to protect against dirt/water ingress, the XNX serves the most demanding industrial environments.

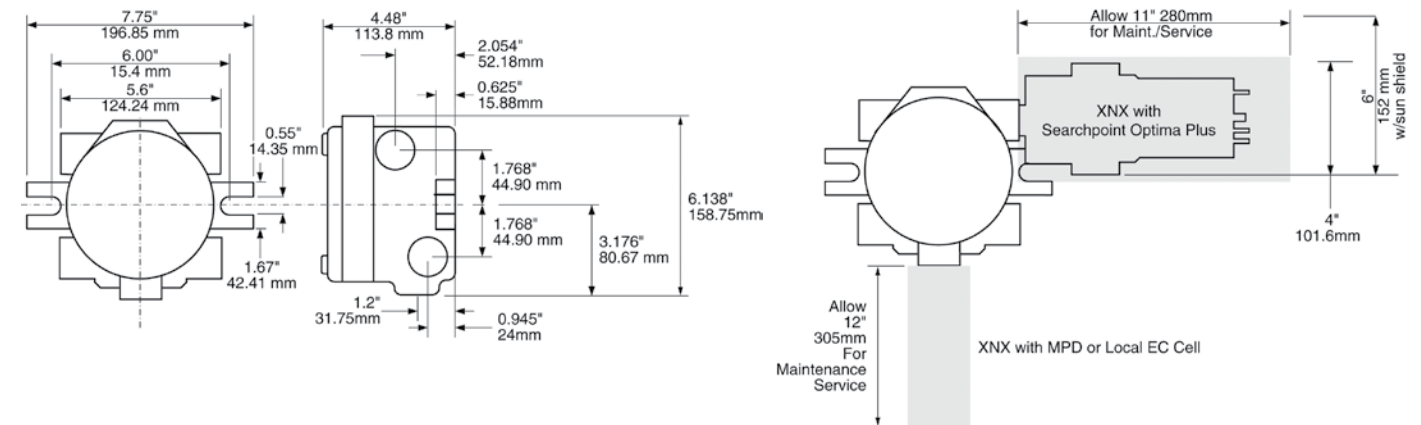

Ordering Information

The XNX part numbering system contains all necessary information to convey the product configuration including options. Agency, Port Thread, Enclosure Material, Sensor Personality define the standard unit. Three option fields are used to define optional Relay or Fieldbus interfaces and factory installed local HART®. To order XNX parts, call 800-538-0363.

XNX-AM ■ ■ - ■ ■ ■ ■ ■ ■

Agency Approval	Port Threads	Enclosure	Sensor	Interface Option	Local HART®	Sensor and Range		
▼	▼	▼	▼	▼	▼	▼	▼	▼
ATEX - A	M25 - M	Stainless - S	Electrochem - E	None - N	None - N	None - NNN		
UL / CSA - U	3/4" NPT - T	Aluminum - A	Infrared - I	Relay - R	Local HART® - H	MPD-AM (Catalytic Bead %LEL) - CB1		
INMETRO - B			milliVolt - V	Modbus® - M		MPD-AMIF1 (IR %LEL Flam) - IF1		
				Foundation™ Fieldbus - F		MPD-AMIV1 (IR CH4 0-5% Vol) - IV1		
						MPD-AMIC1 (IR CO 0-2% Vol) - IC1		

Technical Summary



Technical Summary



XNX Transmitter	
Material	LM25 Aluminum, painted (SS316 painted optional)
Cable Entries	5 conduits/cable entries – (2 right, 2 left, 1 bottom) Available in ¾" NPT, or M25
Termination	Cage Clamp pluggable Terminal Blocks with retaining screws, 0.5 to 2.5mm (12-28 AWG)
Mounting	XNX Enclosure Bracket (ears on casting for u-bolt). Integral cast mounting flanges provide secure mounting to surfaces, channels or up to 6" Pipe. Optional Remote sensor (up to 50 ft / 15.2 M) for Cat Bead and Toxic
User interface	Standard Custom Backlit LCD. 2.5" High Resolution DOT Matrix Display. Discrete Alarm and Status indication. Reliable Non-Intrusive 4 button interface magnetic wand access. Optional HART Handheld with IS Port
Signal	Standard HART over 3-wire 4-20mA (sink or source). Optional Modbus over RS-485 and Foundation Fieldbus
Environmental	
Temperature	-40°C to +65°C / -40°F to +149°F (sensor dependent)
Humidity	20 to 90% RH non-condensing
IP Rating	NEMA 4X IP65
Options	
	Form C and SPDT 3 Relays, 240 VAC, 5A (2 Alarm, 1 Fault) (Mutually exclusive with Modbus and Fieldbus Options)
Power	
	18V to 32V (24V nominal)
Hazardous Area Approvals (Pending)	
	ATEX: Ex II 2 G D, EEx [ia] IIC T5 (Tamb -40°C to +65°C) UL: Class I, Div 1, Groups B, C, and D / Class 1, Zone 1 AEx d IIC T5 (Tamb -40°C to +65°C) CSA: Class I, Div 1, Groups B, C, and D T5 (Tamb -40°C to +65°C)
Performance Approvals (Pending)	EU – ATEX, EN45544, EN50104, EN50270, EN50271, EN13980, EN60079, EN60079-18, -1, -7, -29-1, EN45544-1, -2 NA – UL 913, UL 1203, CSA 22.2 No. 152 Other – IEC61508 (SIL Assessment, SIL 2), IECEx OD 005

Display Module & User Interface (Standard)	
Display Type	Backlit LCD
Information Displayed	Base Information: Gas Reading Gas Name and Units of measurement Fault and Alarm Status Large Numeric concentration or LEL display Bar graph showing current reading, set points and full scale. Fault/Alarm and Operating Status Indication: Security settings allow multi level operator access for set-up, configuration and calibration Event history stores Time and Date of all Alarm, Diagnostic, Configuration events
Interface	Magnetic wand with terminal screwdriver (supplied each unit)

4-20mA & HART (Standard Supply)	
Description	Fully configurable isolated 4-20mA & HART output module providing current sink, current source and isolated modes of operation. (supports HART 6.0 protocol)
Non-intrusive Interface	Optional local IS port to enable HOT connection of a HART handheld configurator
Operating Modes	Current sink / Current source / Isolated current sink /Conventional or with HART data
Output Range	0 to 22mA
4-20mA Signal Accuracy	+/- 1% FS
Max loop resistance	600 Ohms at 24Vdc loop supply
Functions Supported via HART	Gas Reading Gas Name and Units of measurement 4-20mA signal level General/Device Information Installation Configuration Forcing of 4-20mA output
	Detailed Sensor Information Including: Optical Signal Level Dynamic Reserve (Excel Only) Raw reading 24V supply voltage Temperature
	RTC (Excel Only) Calibration and Configuration status Detailed Fault and Warning Information Fault and Alarm History Zero Calibration

Local IS HART Port (Optional)	
Description	Provides externally accessible IS connections to the XNX transmitter to enable HOT connection of HC275/375 HART or equivalent hand held configurator.
Installation	Fitted to one of the cable entries on the XNX transmitter.
Environmental Protection	Terminals protected by cover to IP 66 when not in use

Relay Module (Optional)		
Description	Provides three fully user configurable relay outputs that can be switched based on the current gas level and/or status of the transmitter. Provides 2 x SPCO alarm and 1 x SPCO fault relays. Single Pole Double Throw SPDT. Option PCB Factory installed in display module.	
Installation	Fitted into housing base either at the factory or in the field by qualified service engineer.	
Rating	Maximum: 240VAC, 5A (non inductive load) Minimum: 5V, 10mA (non inductive load)	
Electrical Connections	Fault: Common, Normally Open, Normally Closed Alarm 1: Common, Normally Open, Normally Closed Alarm 2: Common, Normally Open, Normally Closed	
Configuration	Default	Configurable Options
	Fault Relay: Normally energized Non latching Signal inhibit as fault Alarm 1 / 2 Relays: Normally de-energized Non latching Alarm rising on gas reading Alarm level 20% and 40% of scale Hysteresis of 2% of scale	Fault Relay: Normally energized / normally de-energized None Enable/disable A1 / A2 Relays: Normally energized / de-energized Latching / non latching Alarm on rising / falling Alarm level 10% to 90% of full scale
Re-setting of Latched Relays	Easily accessible interface on display (if used) or via HART interface (local or remote)	
Note	Use of the Relay Module or 'Other' Communications Module (E.g. Foundation Fieldbus) is mutually exclusive. However, relay function may be used in conjunction with standard communication output i.e. 4-20mA with HART.	
Relay Specific Functions via HART Interface	Relay status information / Reset of latched conditions / Configuration of relays Forcing of relay state Reset through non intrusive User Interface. Remote Switch closure using Remote Reset input Remotely through HART	
Foundation Fieldbus Module (Optional)		
Description	Foundation Fieldbus compliant digital communications interface enables connection of the XNX transmitter to a multi-drop Foundation Fieldbus H1 network.	
Installation	Fitted into housing base either at the factory or in the field by qualified service engineer.	
Connections	Sig+, Sig- and Screen	
Physical Layer	Conforms to IEC 1158-2 and ISA 50.02, 31.25Kbits/s	
Maximum No. of Nodes	32	
Functions Supported	Gas Reading Gas Name and Units of measurement Instrument status (OK, warning, fault, over-range) General/Device Information Remote zero and span calibration (detector dependent)	Detailed Sensor Information Including: Optical Signal Level Dynamic Reserve (Excel Only) Raw reading 24V supply voltage Temperature RTC (Excel Only) Calibration and Configuration status
		Detailed Fault and Warning Information: Fault and Alarm History Zero Calibration
Modbus RTU Module (Optional)		
Description	The Modbus output module provides an Isolated RS485 output to enable the connection of the XNX transmitter to a multi-drop Modbus network	
Installation	Fitted into housing base either at the factory or in the field by qualified service engineer.	
Connections	RS485+, RS485-, Drain	
Physical Layer	Isolated RS485, 1200 to 19.2K Baud	
Maximum No. of Nodes	254 XNX compatible transmitters only	
Protocol	Modbus RTU	
Functions Supported	As per Foundation Fieldbus Module (Optional) - see above	

Further information is available upon request.

* Foundation Fieldbus not available at time of publication. Please call your Honeywell Analytics sales person.

XNX™ is a registered trademark of Honeywell International.

HART® is a registered trademark of the HART Communication Foundation.

MODBUS® is a registered trademark of Schneider Automation Inc.

Foundation™ is a trademark of Fieldbus Foundation.

Honeywell Analytics Lines of Business



Commercial

Vulcain-brand gas detection from stand-alone units to fully engineered, multi-point systems, all offering cost-effective regulatory compliance

- » Applications: parking structures, chillers, mechanical rooms, office towers, commercial buildings, shopping centers, swimming pools, golf courses, schools and universities, laboratories

Industrial

Renowned Sieger and Manning gas detection systems with advanced electrochemical, infrared and open path sensing technologies

- » Applications: oil and gas, cold storage, water/wastewater treatment, chemicals, engine rooms, plastics and fibers, agriculture, printing and light industrial

Portables

Single or multi-gas Lumidor and other premium detectors with compact, lightweight designs ranging from simple alarm only units to advanced, fully configurable and serviceable instruments

- » Applications: underground utility and electricity ducts, boiler rooms, post-fire sites, sewers, industrial plants, industrial hygiene, first responder teams, remote fleets

Authorized Distributor:
GasDetectorsUSA.com
Houston, TX USA
832-615-3588
sales@GasDetectorsUSA.com



High Tech/Government

A complete portfolio of gas and chemical detection instrumentation including infrared spectroscopy (MST) with no cross interference, to Chemcassette paper-based solutions (MDA Scientific) offering detection down to parts per billion

- » Applications: semiconductor manufacturing and nanotechnology, aerospace propulsion and safety, specialty chemicals industry, research laboratories, emergency response

Technical Services

24/7 global network includes post-sales service and Systems Integration teams

- » Emergency call out, service contracts, on/off-site repair, training and commissioning
- » Complete range of spares, consumables and accessories



Honeywell
AUTHORIZED DISTRIBUTOR

De Gidts & Feldman BV
The Netherlands
www.dgfg.nl

 **De Gidts & Feldman**
INSTRUMENTATION & FILTRATION

Please Note:

While every effort has been made to ensure accuracy in this publication, no responsibility can be accepted for errors or omissions. Data may change, as well as legislation, and you are strongly advised to obtain copies of the most recently issued regulations, standards, and guidelines. This publication is not intended to form the basis of a contract.