

STD700 SmartLine Differential Pressure Specification 34-ST-03-101, March 2024



Introduction

Part of the SmartLine® family of products, the STD700 is suitable for monitoring, control and data acquisition featuring piezoresistive sensor technology. By combining pressure sensing with on chip temperature compensation capabilities STD700 offers high accuracy, stability and performance over a wide range of application pressures and temperatures. The SmartLine family is also fully tested and compliant with Experion® PKS providing the highest level of compatibility assurance and integration capabilities. SmartLine easily meets the most demanding application needs for pressure measurement applications.

Best in Class Features:

- Accuracies up to 0.05% of span standard & 0.04% of span optional.
- Stability up to 0.02% of URL per year for 10 years.
- Automatic static pressure & temperature compensation.
- Rangeability up to 100:1.
- Response times as fast as 100ms.
- Multiple local display capabilities.
- External zero, span, & configuration capability.
- Polarity insensitive electrical connections.
- Comprehensive on-board diagnostic capabilities.
- Integral Dual Seal design for highest safety based on ANSI/NFPA 70-202 and ANSI/ISA 12.27.0.
- World class overpressure protection.
- Full compliance to SIL 2/3 requirements.
- Modular design characteristics
- Available with additional 4-year warranty

Communications/Output Options:

- Honeywell Digitally Enhanced (DE)
- HART® (version 7.0)

All transmitters are available with the above listed communications protocols.



Figure 1 – STD700 Differential Pressure Transmitters feature field-proven piezoresistive sensor technology

Span & Range Limits:

Model	URL inH ₂ O (mbar)	LRL inH ₂ O (mbar)	Min Span inH ₂ O (mbar)
STD720	400 (1000)	-400 (1000)	4 (10)
Model	psi (bar)	psi (bar)	psi (bar)
STD730	100 (7.0)	-100 (-7.0)	1 (0.07)
STD770	3000 (210)	-100 (-7.0)	30 (2.1)

Description

The SmartLine family pressure transmitters are designed around a high performance piezo-resistive sensor. This one sensor actually integrates multiple sensors linking process pressure measurement with on-board static pressure (DP Models) and temperature compensation measurements. This level of performance allows the ST 700 to replace most competitive transmitters available today.

Unique Indication/Display Option

The ST 700 modular design accommodates a standard alphanumeric LCD display or a unique advanced graphics LCD display with many unparalleled features.

Standard LCD Display Features

- Modular (may be added or removed in the field).
- Supports HART protocol variant.
- 0, 90, 180, & 270 degree position adjustments.
- Four configurable screens.
- Standard and custom measurement units available.
- Display calculated flow (square root) value in addition to analog output signal.
- 2 Lines 6 digits PV (9.95H x 4.20W mm) 8 Characters.
- Write protect Indication.
- Built-in Basic Device Configuration through Internal or External Buttons – Range/Engineering Unit/Loop Test /Loop Calibration/Zero /Span Setting.
- Multiple language capabilities (EN, RU).

Advanced LCD Display Features

- Modular (may be added or removed in the field)
- 0, 90, 180, & 270 degree position adjustments.
- Standard and custom measurement units available.
- Up to eight display screens with 3 formats are possible.
- Large PV with Bar Graph or PV with Trend Graph.
- Configurable screen rotation timing (1 to 30 sec).
- Display calculated flow (square root) value in addition to analog output signal.
- Unique “Health Watch” indication provides instant visibility of diagnostics.
- Multiple language capability (EN, DE, FR, IT, ES, RU, TR, CN, & JP).

Diagnostics

SmartLine transmitters all offer digitally accessible diagnostics which aid in providing advanced warning of possible failure events minimizing unplanned shutdowns, providing lower overall operational costs.

System Integration

- SmartLine communications protocols all meet the most current published standards for HART/DE.
- Integration with Honeywell's Experion PKS offers the following unique advantages.
 - Tamper reporting
 - FDM Plant Area Views with Health summaries
 - All ST 700 units are Experion tested to provide the highest level of compatibility assurance.

Configuration Tools

Integral Three Button Configuration Option

Suitable for all electrical and environmental requirements, SmartLine offer the ability to configure the transmitter and display via three externally accessible buttons when either display option is selected. Zero/span capabilities are also optionally available via these buttons with or without selection of a display option.

Handheld Configuration

SmartLine transmitters feature two-way communication and configuration capability between the operator and the transmitter. All Honeywell transmitters are designed and tested for compliance with the offered communication protocols and are designed to operate with any standards compliant handheld configuration device, such as Honeywell Versatilis Configurator.

Personal Computer Configuration

On a personal computer or laptop, Honeywell Field Device Manager (FDM) Software and FDM Express can be used for managing HART device configurations.

Modular Design

To help contain maintenance & inventory costs, all ST 700 transmitters are modular in design supporting the user's ability to replace meter bodies, add indicators or change electronic modules without affecting overall performance or approval body certifications. Each meter body is uniquely characterized to provide in-tolerance performance over a wide range of application variations in temperature and pressure and due to the Honeywell advanced interface, electronic modules may be swapped with any electronics module without losing in-tolerance performance characteristics.

Modular Features

- Meter body replacement
- Exchange/replace electronics/comms modules*
- Add or remove integral indicator*
- Add or remove lightning protection (terminal connection)*

* Field replaceable in all electrical environments (including IS) except flameproof without violating agency approvals.

With no performance effects, Honeywell's unique modularity results in **lower inventory needs and lower overall operating costs.**

Performance Specifications

Reference Accuracy (conformance to +/-3 Sigma)

Table 1

Model	URL	LRL	Min Span	Maximum Turndown Ratio	Stability (% URL/Year for 10 years)	Reference Accuracy ^{1,2} (% Span) Standard/ optional
STD720	400 in H ₂ O (1000 mbar)	-400 in H ₂ O (-1000 mbar)	4 in H ₂ O (10 mbar)	100:1	0.020	0.05 / 0.04
STD730	100 psi (7.0 bar)	-100 psi (-7.0 bar)	1 psi (0.07 bar)	100:1	0.020	
STD770	3000 psi (210 bar)	-100 psi (-7.0 bar)	30 psi (2.1bar)	100:1	0.020	

Table 1

Zero and span may be set anywhere within the listed (URL/LRL) range limits

Accuracy at Specified Span, Temperature and Static Pressure Effects: (conformance to +/-3)

Table 2

		Accuracy ^{1,2} (% of Span)					Combined Zero & Span temperature Effect (% Span / 28°C (50°F))		Combined Zero & Span Static Line Pressure Effect (% Span/1000psi)	
	Model	URL	Reference Turndown	A	B	C (see URL units)	D	E	F	G
Standard Accuracy	STD720	400 in H ₂ O (1000 mbar)	16:1	0.005	0.045	25 (62.5)	0.050	0.020	0.100	0.010
	STD730	100 psi (7.0 bar)	4:1			25 (1.75)				
	STD770	3000 psi (210 bar)	10:1			300 (21)	0.065	0.010		
High Accuracy option	STD720	400 in H ₂ O (1000 mbar)	16:1	0.005	0.035	25 (62.5)	0.050	0.020	0.100	0.010
	STD730	100 psi (7.0 bar)	4:1			25 (1.75)				
	STD770	3000 psi (210 bar)	10:1			300 (21)	0.065	0.010		
Turn Down Effect						Temp Effect		Static Effect		
$\pm [A + B] \text{ if Span} \geq C$ $\pm \left[A + B \left(\frac{C}{Span} \right) \right] \text{ if Span} < C$						$\pm \left[D + E \left(\frac{URL}{Span} \right) \right]$		$\pm \left[F + G \left(\frac{URL}{Span} \right) \right]$		

Total Performance (% of Span):

$$\text{Total Performance} = \sqrt{(\text{Accuracy})^2 + (\text{Temp Effect})^2 + (\text{Static Line Pressure Effect})^2} \quad +/-$$

Total Performance Examples (for comparison): standard accuracy, 5:1 Turndown, up to 50°F (28°C) shift & up to 1000 psi Static Pressure

STD720 @ 80 inH₂O: 0.218% of span

STD730 @ 20 psi: 0.199 % of span

STD770 @ 600 psi: 0.196 % of span

Typical Calibration Frequency:

Calibration verification is recommended every two (2) years.

Notes:

1. Terminal Based Accuracy – Includes combined effects of linearity, hysteresis and repeatability. Analog output adds 0.005% of span.
2. For zero based spans and reference conditions of: 25°C (77°F), 0 psig static pressure, 10 to 55% RH and 316SS barrier diaphragm.

Operating Conditions – All Models

Parameter	Reference Condition		Rated Condition		Operative Limits		Transportation and Storage	
	°C	°F	°C	°F	°C	°F	°C	°F
Ambient Temperature ¹	25±1	77±2	-40 to 85	-40 to 185	-40 to 85	-40 to 185	-55 to 120	-67 to 248
Meter Body Temperature ²	25±1	77±2	-40 to 110	-40 to 230	-40 to 125	-40 to 257	-55 to 120	-67 to 248
Humidity %RH	10 to 55		0 to 100		0 to 100		0 to 100	
Vac. Region – Min. Pressure								
mmHg absolute inH ₂ O absolute	Atmospheric Atmospheric		25 13		2 (short term) ³ 1 (short term) ³			
Supply Voltage Load Resistance	HART: 10.8 to 42.4 VDC at terminals (IS versions limited to 30 VDC), 0 to 1,440 ohms DE: 15 to 49.3VDC at terminals (IS versions limited to 30VDC), 0 to 1,200 ohms (as shown in Figure 2)							
Maximum Allowable Working Pressure (MAWP) ^{4,5} (ST 700 products are rated to Maximum Allowable Working Pressure. MAWP depends on Approval Agency and transmitter materials of construction.)	4,500 psi (310 bar)							

- ¹ LCD Display operating temperature -20°C to +70°C. Storage temperature -30°C to 80°C.
- ² Silicone 704 minimum temperature rating is 0°C (32°F). CTFE minimum temperature rating is -40°C (-40°F). NEOBEE® M-20 minimum temperature rating is -15°C (5°F). NEOBEE® is a registered trademark of Stepan Company.
- ³ Short term equals 2 hours at 70°C (158°F).
- ⁴ MAWP applies for temperatures -40 to 125°C. Static Pressure Limit is de-rated to 3,000 psi for -26°C to -40°C. for all models. Use of graphite o-rings de-rates transmitter to 3,625 psi. Use of 1/2:" process adaptors with graphite o-rings de-rates transmitter to 3,000 psi.
- ⁵ Consult factory for MAWP of ST 700 transmitters with CRN approval.

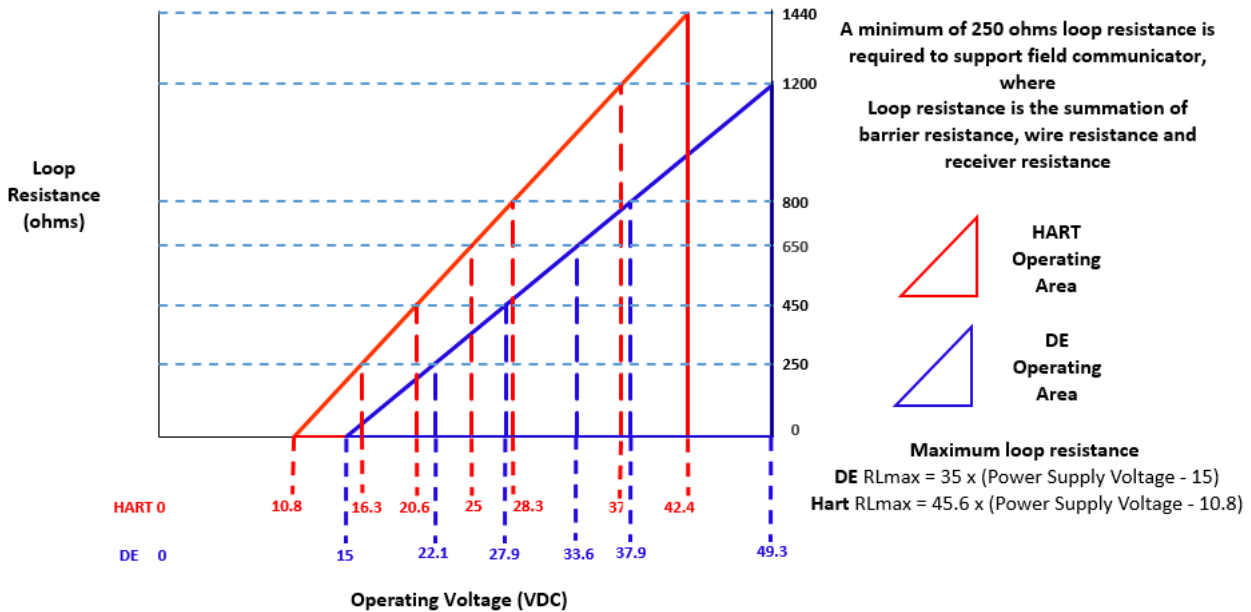

Figure 2 - Supply voltage and loop resistance chart & calculations

Performance Under Rated Conditions – All Models

Parameter	Description									
Analog Output Digital Communications:	Two-wire, 4 to 20 mA (HART & DE Transmitters only) Honeywell DE, HART protocol. All transmitters, irrespective of protocol have polarity insensitive connections.									
HART & DE Output Failure Modes (NAMUR for DE Units requires selecting display and configuration buttons or factory configuration)	<table border="0"> <thead> <tr> <th></th> <th>Honeywell Standard</th> <th>NAMUR NE 43 Compliance</th> </tr> </thead> <tbody> <tr> <td>Normal Limits:</td> <td>3.8 – 20.8 mA</td> <td>3.8 – 20.5 mA</td> </tr> <tr> <td>Failure Mode:</td> <td>≤ 3.6 mA and ≥ 21.0 mA</td> <td>≤ 3.6 mA and ≥ 21.0 mA</td> </tr> </tbody> </table>		Honeywell Standard	NAMUR NE 43 Compliance	Normal Limits:	3.8 – 20.8 mA	3.8 – 20.5 mA	Failure Mode:	≤ 3.6 mA and ≥ 21.0 mA	≤ 3.6 mA and ≥ 21.0 mA
	Honeywell Standard	NAMUR NE 43 Compliance								
Normal Limits:	3.8 – 20.8 mA	3.8 – 20.5 mA								
Failure Mode:	≤ 3.6 mA and ≥ 21.0 mA	≤ 3.6 mA and ≥ 21.0 mA								
Supply Voltage Effect	0.005% span per volt.									
Transmitter Turn on Time (includes power up & test algorithms)	HART or DE: 2.5 seconds									
Response Time (delay + time constant)	<u>DE/HART Analog Output</u> 100ms									
Damping Time Constant	HART: Adjustable from 0 to 32 seconds in 0.1 increments. Default: 0.50 seconds DE: Discrete values 0, .16, .32, .48, 1, 2, 4, 8, 16, 32 seconds. Default: 0.48 seconds									
Vibration Effect	Less than +/- 0.1% of URL w/o damping Per IEC60770-1 field or pipeline, high vibration level (10-2000Hz: 0.21 displacement/3g max acceleration)									
Electromagnetic Compatibility	IEC 61326-3-1									
Lightning Protection Option	Leakage Current: 10uA max @ 42.4VDC 93C Impulse rating: 8/20us 5000A (>10 strikes) 10000A (1 strike min.) 10/1000us 200A (> 300 strikes)									

Materials Specifications (see model selection guide for availability/restrictions with various models)

Parameter	Description
Barrier Diaphragms Material	316L SS, Hastelloy® C-276 ² , Monel® 400 ³ , Tantalum
Process Head Material	316 SS ⁴ , Carbon Steel (Zinc-plated) ⁵ , Hastelloy C-276 ⁶
Vent/Drain Valves & Plugs ¹	316 SS ⁴ , Hastelloy C-276 ²
Head Gaskets	Glass-filled PTFE standard. Viton® and graphite are optional.
Meter Body Bolting	Carbon Steel (Zinc plated) standard. Options include 316 SS, NACE A286 SS bolts, Monel K500, Super Duplex and B7M.
Optional Adapter Flange and Bolts	Adapter Flange materials include 316 SS, Hastelloy C-276 and Monel 400. Bolt material for flanges is dependent on process head bolts material chosen. Standard adaptor seal material is glass-filled PTFE. Viton and graphite are optional.
Mounting Bracket	2" Pipe, Carbon Steel (Zinc-plated) or 304 Stainless Steel or 316 Stainless Steel
Fill Fluid	Silicone 200, CTFE, NEOBEE M-20 or Silicone 704.
Electronic Housing	Pure Polyester Powder Coated Low Copper (<0.4%) – Aluminum. Meets Type 4X / IP66 / IP67. All stainless-steel housing is optional. Cover O ring material: Silicone.
Mounting	Can be mounted in virtually any position using the standard mounting bracket. Bracket is designed to mount on 2-inch (50 mm) vertical or horizontal pipe. See Figure 3.
Process Connections	1/4- NPT or 1/2- NPT with adapter (meets DIN requirements)
Wiring	Accepts up to 16 AWG (1.5 mm diameter).
Dimensions	See Figure 4.
Net Weight	8.3 pounds (3.8 Kg) with Aluminum Housing.

¹ Vent/Drains are sealed with Teflon®

² Hastelloy C-276 or UNS N10276

³ Monel 400 or UNS N04400

⁴ Supplied as 316 SS or as Grade CF8M, the casting equivalent of 316 SS.

⁵ Carbon Steel heads are zinc-plated and not recommended for water service due to hydrogen migration. For that service, use 316 stainless steel wetted Process Heads.

⁶ Hastelloy C-276 or UNS N10276. Supplied as indicated or as Grade CW12MW, the casting equivalent of Hastelloy C-276

Communications Protocols & Diagnostics

HART Protocol

Version: HART 7

Honeywell Digitally Enhanced (DE)

DE is a Honeywell proprietary protocol which provides digital communications between Honeywell DE enabled field devices and hosts.

Standard Diagnostics

ST 700 top level diagnostics are reported as either critical or non-critical and are readable via the DD/DTM/FDI tools or integral display. All critical diagnostics will appear on the Advanced and Standard integral displays, and some non-critical diagnostics will also appear on the Advanced integral display. Some of the diagnostics are listed below.

Critical Diagnostics

- Electronics Module Fault.
- Meter body Memory Corruption.
- Config Data Corruption.
- Electronics Module Diagnostics Failure.
- Meter body Critical Failure.
- Sensor Communication Timeout.









Non-Critical Diagnostics

- Electronics Module Fault.
- Display Failure.
- Electronics Module Comm Failure.
- Meter body Excess Correct.
- Sensor Over Temperature.
- Fixed Current Mode.
- PV Out of Range.
- No DAC Compensation.
- Tamper Attempt Alarm.

Refer to the product user manual for comprehensive list of diagnostics and details.

Hazardous Areal Certifications

MSG CODE	AGENCY	TYPE OF PROTECTION	COMM. OPTION	ELECTRICAL PARAMETERS	AMBIENT TEMP (Ta)
A	FM Approvals™ USA	Explosionproof: Class I, Division 1, Groups A, B, C, D; Dust Ignition Proof: Class II, III, Division 1, Groups E, F, G; T6..T5 Class I, Zone 0/1, AEx db IIC T6..T5 Ga/Gb Class II, Zone 21, AEx tb IIIC T95° Db	All	Note 1	T5: -50 °C to 85°C T6: -50 °C to 65°C
		Intrinsically Safe: Class I, II, III, Division 1, Groups A, B, C, D, E, F, G: T4 Class I, Zone 0, AEx ia IIC T4 Ga FISCO Field Device (Only for FF Option) Ex ia IIC T4 Ga; Ex ic IIC T4 Gc	4-20 mA / DE/ HART	Note 2a	-50 °C to 70°C
		Nonincendive: Class I, Division 2, Groups A, B, C, D locations, T4 Class I, Zone 2, AEx nA IIC T4 Gc	Foundation Fieldbus	Note 2b	-50 °C to 70°C
		Nonincendive: Class I, Division 2, Groups A, B, C, D locations, T4 Class I, Zone 2, AEx nA IIC T4 Gc	4-20 mA / DE/ HART/ Foundation Fieldbus	Note 1	-50 °C to 85°C
		Enclosure: Type 4X/ IP66/ IP67	All	All	-
		STANDARDS: FM Class 3600:2011; FM Class 3610: 2010; FM Class 3611: 2004; FM Class 3615: 2006; FM Class 3616: 2011; FM Class 3810: 2005; ANSI/ISA 60079-0: 2013; ANSI/UL 60079-1: 2015; ANSI/UL 60079-11: 2014; ANSI/ISA 60079-15: 2012; ANSI/UL 60079-26: 2017; ANSI/UL 60079-31: 2015; ANSI/NEMA 250: 2003; ANSI/ IEC 60529: 2004			
B	Canadian Standards Association (CSA) USA and Canada	Explosion Proof: Class I, Division 1, Groups A, B, C, D; Class II, Division 1, Groups E, F, G; Class III, Division 1, T6..T5 Class I Zone 1 AEx db IIC T6..T5 Ga/Gb Ex db IIC T6..T5 Ga/Gb Zone 22 AEx tb IIIC T95° Db Ex tb IIIC T95° Db	All	Note 1	T5: -50°C TO 85°C T6: -50°C TO 65°C
		Intrinsically Safe: Class I, II, III, Division 1, Groups A, B, C, D; Class II, Division 1, Groups E, F, G; Class III, Division 1, T4 Class I Zone 0, AEx ia IIC T4 Ga Class I Zone 2, AEx ic IIC T4 Gc Ex ia IIC T4 Ga Ex ic IIC T4 Gc FISCO Field Device (Only for FF Option) Ex ia IIC T4 Ga; Ex ic IIC T4 Gc	4-20 mA / DE/ HART	Note 2	-50°C TO 70°C
		Nonincendive: Class I, Division 2, Groups A, B, C, D; Class II, Division 2, Groups F, G; Class III, Division 2, T4 Class I Zone 2 AEx nA IIC T4 Gc Ex nA IIC T4 Gc	Foundation Fieldbus	Note 2	-50°C TO 70°C
		Nonincendive: Class I, Division 2, Groups A, B, C, D; Class II, Division 2, Groups F, G; Class III, Division 2, T4 Class I Zone 2 AEx nA IIC T4 Gc Ex nA IIC T4 Gc	4-20 mA / DE/ HART/ Foundation Fieldbus	Note 1	-50°C to 85°C
		Enclosure: Type 4X/ IP66/ IP67	All	All	-

MSG CODE	AGENCY	TYPE OF PROTECTION	COMM. OPTION	ELECTRICAL PARAMETERS	AMBIENT TEMP (Ta)
		STANDARDS: CSA C22.2 No. 0-10; CSA C22.2 No. 94-M91; CSA C22.2 No. 25-1966; CSA C22.2 No. 30-M1986; CSA C22.2 No. 142-M1987; CSA C22.2 No. 157-92; CSA C22.2 No. 213-M1987; CSA-C22.2 No. 60529:05; CSA-C22.2 No. 60079-0:11; CSA-C22.2 No. 60079-1:11; CSA-C22.2 No. 60079-11:11; CSA-C22.2 No. 60079-15:12; CSA-C22.2 No. 60079-31:12; ISA 12.12.01-2010; ISA 60079-0: 2009; ISA 60079-11: 2011; ISA 60079-15: 2009; ISA 60079-26: 2008; ISA-60079-27:2007 (12.02.04)-2006 (R2011); UL 913 Ed. 6; UL 916:1998; ANSI/ISA-12.27.01-2011			
C	ATEX	Flameproof: SIRA 12ATEX2233X  II 1/2 G Ex db IIC T6..T5 Ga/Gb II 2 D Ex tb IIIC T95°C...T120°C Db	All	Note 1	T5: -50°C TO 85°C T6: -50°C TO 65°C
		Intrinsically Safe: SIRA 12ATEX2233X  II 1 G Ex ia IIC T4 Ga II 2 D Ex ia IIIC T125°C Db FISCO Field Device (Only for FF Option) II 1 G Ex ia IIC T4 Ga	4-20 mA / DE/ HART	Note 2	-50°C TO 70°C
		Zone 2, Increase Safety: SIRA 12ATEX4234X  II 3 G Ex ec IIC T4 Gc	4-20 mA / DE/ HART/	Note 1	-50°C TO 85°C
		Zone 2, Intrinsically Safe: SIRA 12ATEX4234X  II 3 G Ex ic IIC T4 Gc FISCO Field Device (Only for FF Option) II 3 G Ex ic IIC T4 Gc	4-20 mA / DE/ HART/ Foundation Fieldbus	Note 2	-50°C TO 85°C
		Enclosure: IP66/ IP67	All	All	-
		STANDARDS: EN 60079-0: 2018; EN 60079-1: 2014; EN 60079-7: 2015+A1:2018; EN 60079-11: 2012; EN 60079-26: 2015; EN 60079-31: 2014			
	UKEx	Flameproof: CSAE 22UKEX1021X  II 1/2 G Ex db IIC T6..T5 Ga/Gb II 2 D Ex tb IIIC T95°C...T120°C Db	All	Note 1	T5: -50°C TO 85°C T6: -50°C TO 65°C
		Intrinsically Safe: CSAE 22UKEX1021X  II 1 G Ex ia IIC T4 Ga II 2 D Ex ia IIIC T125°C Db FISCO Field Device (Only for FF Option) II 1 G Ex ia IIC T4 Ga	4-20 mA / DE/ HART	Note 2	-50°C TO 70°C
		Zone 2, Increase Safety: CSAE 22UKEX1008X  II 3 G Ex ec IIC T4 Gc	4-20 mA / DE/ HART/	Note 1	-50°C TO 85°C
		Zone 2, Intrinsically Safe: CSAE 22UKEX1009X  II 3 G Ex ic IIC T4 Gc FISCO Field Device (Only for FF Option) II 3 G Ex ic IIC T4 Gc	4-20 mA / DE/ HART/ Foundation Fieldbus	Note 2	-50°C TO 85°C
		Enclosure: IP66/ IP67	All	All	-
		STANDARDS: EN 60079-0: 2018; EN 60079-1: 2014; EN 60079-7: 2015+A1:2018; EN 60079-11: 2012; EN 60079-26: 2015; EN 60079-31: 2014			

MSG CODE	AGENCY	TYPE OF PROTECTION		COMM. OPTION	ELECTRICAL PARAMETERS	AMBIENT TEMP (Ta)
		STANDARDS: EN 60079-0: 2018; EN 60079-1: 2014; EN 60079-7: 2015+A1:2018; EN 60079-11: 2012; EN 60079-26: 2015; EN 60079-31: 2014				
D	IECEX World	Flameproof: IECEx SIR 12.0100X Ex db IIC T6..T5 Ga/Gb Ex tb IIIC T95°C...T120°C Db		All	Note 1	T5: -50°C TO 85°C T6: -50°C TO 65°C
		Intrinsically Safe: IECEx SIR 12.0100X Ex ia IIC T4 Ga Ex ia IIIC T125°C Db FISCO Field Device (Only for FF Option) Ex ia IIC T4 Ga; Ex ic IIC T4 Gc		4-20 mA / DE/ HART	Note 2	-50°C TO 70°C
				Foundation Fieldbus	Note 2	-50°C TO 70°C
		Zone 2, Increase Safety: IECEx SIR 12.0100X Ex ec IIC T4 Gc		4-20 mA / DE/ HART/ Foundation Fieldbus	Note 1	-50°C TO 85°C
		Zone 2, Intrinsically Safe: IECEx SIR 12.0100X Ex ic IIC T4 Gc FISCO Field Device (Only for FF Option) Ex ic IIC T4 Gc		4-20 mA / DE/ HART/ Foundation Fieldbus	Note 2	-50°C TO 85°C
		Enclosure: IP66/ IP67		All	All	-
STANDARDS: IEC 60079-0: 2017; IEC 60079-1: 2014; IEC 60079-7: 2017; IEC 60079-11: 2011; IEC 60079-26: 2014; IEC 60079-31: 2013						
E	SAEx South Africa	Flameproof : Ex d IIC T6...T5 Ga/Gb Ex tb IIIC T95°C...T120°C Db		All	Note 1	T5: -50°C TO 85°C T6: -50°C TO 65°C
		Intrinsically Safe: Ex ia IIC Ga T4 FISCO Field Device (Only for FF Option) Ex ia IIC T4 Ga; Ex ic IIC T4 Gc		4-20 mA / DE/ HART	Note 2	-50°C TO 70°C
				Foundation Fieldbus	Note 2	-50°C TO 70°C
		Zone 2, Increase Safety: II 3 G Ex ec IIC T4 Gc		4-20 mA / DE/ HART/ Foundation Fieldbus	Note 1	-50°C TO 85°C
		Zone 2, Intrinsically Safe: Ex ic IIC T4 Gc FISCO Field Device (Only for FF Option) Ex ic IIC T4 Gc		4-20 mA / DE/ HART/ Foundation Fieldbus	Note 2	-50°C TO 85°C
		Enclosure: IP66/ IP67		All	All	-

MSG CODE	AGENCY	TYPE OF PROTECTION	COMM. OPTION	ELECTRICAL PARAMETERS	AMBIENT TEMP (Ta)
F	INMETRO Brazil	Flameproof: Ex db IIC T6..T5 Ga/Gb Ex tb IIIC T95°C...T120°C Db	All	Note 1	T5: -50°C TO 85°C T6: -50°C TO 65°C
		Intrinsically Safe: Ex ia IIC T4 Ga	4-20 mA / DE/ HART	Note 2a	-50°C TO 70°C
		FISCO Field Device (Only for FF Option) Ex ia IIC T4 Ga; Ex ic IIC T4 Gc	Foundation Fieldbus	Note 2b	-50°C TO 70°C
		Zone 2, Increase Safety: II 3 G Ex ec IIC T4 Gc	4-20 mA / DE/ HART/ Foundation Fieldbus	Note 1	-50°C TO 85°C
		Zone 2, Intrinsically Safe: Ex ic IIC T4 Gc FISCO Field Device (Only for FF Option) Ex ic IIC T4 Gc	4-20 mA / DE/ HART/ Foundation Fieldbus	Note 2	-50°C TO 85°C
		Enclosure : IP 66/67	All	All	-
G	NEPSI CHINA	Flameproof: Ex db IIC T6..T5 Ga/Gb Ex tb IIIC T 95°C Db	All	Note 1	T5: -50°C TO 85°C T6: -50°C TO 65°C
		Intrinsically Safe: Ex ia IIC T4 Ga	4-20 mA / DE/ HART	Note 2	-50°C TO 70°C
		FISCO Field Device (Only for FF Option) Ex ia IIC T4 Ga; Ex ic IIC T4 Gc	Foundation Fieldbus	Note 2	-50°C TO 70°C
		Zone 2, Increase Safety: II 3 G Ex ec IIC T4 Gc	4-20 mA / DE/ HART/ Foundation Fieldbus	Note 1	-50°C TO 85°C
		Zone 2, Intrinsically Safe: Ex ic IIC T4 Gc FISCO Field Device (Only for FF Option) Ex ic IIC T4 Gc	4-20 mA / DE/ HART/ Foundation Fieldbus	Note 2	-50°C TO 85°C
		Enclosure : IP 66/67	All	All	-
H	KOSHA Korea	Flameproof : Ex d IIC T4, T5, T6 Ex tD A21 IP66/IP67 T95°C...T120°C	All	Note 1	T4: -50°C TO 85°C T5: -50°C TO 85°C T6: -50°C TO 65°C
		Intrinsically Safe: Ex ia IIC T4	4-20 mA / DE/ HART	Note 2	Ta= -50 °C to 70°C
			Foundation Fieldbus	Note 2	Ta= -50 °C to 70°C
	Enclosure: IP66/ IP67	All	All	-	
I	EAC Russia, Belarus and Kazakhstan	Flameproof: Ga/Gb Ex d IIC T6..T5 Ex tb IIIC Db T 85°C	All	Note 1	T5: -50°C TO 85°C T6: -50°C TO 65°C
		Intrinsically Safe: Ga Ex ia IIC T4 X	4-20 mA / DE/ HART	Note 2	-50°C TO 70°C

		FISCO Field Device (Only for FF Option) Ga Ex ia IIC T4 X	Foundation Fieldbus	Note 2	-50°C TO 70°C
		Zone 2, Non Sparking: 2 Ex nA IIC T4 Gc X	4-20 mA / DE/ HART/ Foundation Fieldbus	Note 1	-50°C TO 85°C
		Zone 2, Intrinsically Safe: Ga Ex ic IIC T4 X FISCO Field Device (Only for FF Option) 2 Ex ic IIC T4 Gc X	4-20 mA / DE/ HART/ Foundation Fieldbus	Note 2	-50°C TO 85°C
		Enclosure : IP 66/67	All	All	
J	CCoE INDIA	Flameproof: Ex d IIC T6..T5 Ga/Gb	All	Note 1	T5: -50°C TO 85°C T6: -50°C TO 65°C
		Intrinsically Safe: Ex ia IIC T4 Ga FISCO Field Device (Only for FF Option) Ex ia IIC T4 Ga; Ex ic IIC T4 Gc	4-20 mA / DE/ HART	Note 2	-50°C TO 70°C
			Foundation Fieldbus	Note 2	-50°C TO 70°C
		Non Sparking Ex nA IIC T4 Gc	4-20 mA / DE/ HART/ Foundation Fieldbus	Note 1	-50°C TO 85°C
		Enclosure: IP66/ IP67	All	All	-
K	UATR UKRAINE	Flameproof: II 1/2 G Ex db IIC T6..T5 Ga/Gb II 2 D Ex tb IIIC T95°C...T120°C Db	All	Note 1	T5: -50°C TO 85°C T6: -50°C TO 65°C
		Intrinsically Safe: II 1 G Ex ia IIC T4 Ga FISCO Field Device (Only for FF Option) II 1 G Ex ia IIC T4 Ga	4-20 mA / DE/ HART	Note 2	-50°C TO 70°C
			Foundation Fieldbus	Note 2	-50°C TO 70°C
		Enclosure: IP66/ IP67	All	All	-

Notes:

1. Operating Parameters:

Voltage = 11 to 42 VDC	Current = 4-20 mA Normal
= 9 to 32 V (FF)	= 30 mA (FF)
2. Intrinsically Safe Entity Parameters
 - a. Analog/ DE/ HART Entity Values:

Vmax = Ui = 30V	Imax = li = 105mA	Ci = 4.2nF	Li = 984 uH	Pi = 0.9W
Transmitter with Terminal Block Revision E or Later				
Vmax = Ui = 30V	Imax = li = 225mA	Ci = 4.2nF	Li = 0	Pi = 0.9W

 Note: Transmitter with Terminal Block Revision E or later
 The revision is on the label that is on the module. There will be two lines of text on the label:
 - First is the Module Part #: 50049839-001 or 50049839-002
 - Second line has the supplier information, along with the REVISION: XXXXXXX-EXXXX, THE "X" is production related, THE POSITION of the "E" IS THE REVISION.
 - b. Foundation Fieldbus Entity Values

Vmax = Ui = 30V	Imax= li = 180mA	Ci = 0nF	Li = 984 uH	Pi = 1W
Transmitter with Terminal Block Revision F or Later				
Vmax = Ui = 30V	Imax = li = 225mA	Ci = 0nF	Li = 0	Pi = 1 W

 FISCO Field Device
 Vmax = Ui = 17.5V Imax = li = 380 mA Ci = 0nF Li = 0 Pi = 5.32 W
 Note: Transmitter with Terminal Block Revision F or later
 The revision is on the label that is on the module. There will be two lines of text on the label:
 - First is the Module Part #: 50049839-003 or 50049839-004
 - Second line has the supplier information, along with the REVISION: XXXXXXX-EXXXX, THE "X" is production related, THE POSITION of the "E" IS THE REVISION.

Approval Certifications

Marine Certificates	This certificate defines the certifications covered for the ST 800 Pressure Transmitter family of products, including the SMV 800 Smart Multivariable Transmitter. It represents the compilation of the five certificates Honeywell currently has covering the certification of these products into marine applications.
	For SmartLine Pressure Transmitter and SMV800 Smart Multivariable Transmitter
	American Bureau of Shipping (ABS) - 2009 Steel Vessel Rules 1-1-4/3.7, 4-6-2/5.15, 4-8-3/13 & 13.5, 4-8-4/27.5.1, 4-9-7/13. Certificate number: 04-HS417416-PDA
	Bureau Veritas (BV) - Product Code: 389:1H. Certificate number: 12660/B0 BV
	Det Norske Veritas (DNV) - Location Classes: Temperature D, Humidity B, Vibration A, EMC B, Enclosure C. For salt spray exposure; enclosure of 316 SST or 2-part epoxy protection with 316 SST bolts to be applied. Certificate number: A-11476
	Korean Register of Shipping (KR) - Certificate number: LOX17743-AE001
Lloyd's Register (LR) - Certificate number: 02/60001(E1) & (E2)	
SIL 2/3 Certification	IEC 61508 SIL 2 for non-redundant use and SIL 3 for redundant use according to EXIDA and TÜV Nord Sys Tec GmbH & Co. KG under the following standards: IEC61508-1: 2010; IEC 61508-2: 2010; IEC61508-3: 2010.

Other Certification Options

Materials

NACE MRO175, MRO103, ISO15156

Mounting & Dimensional Drawings

Reference Dimensions: $\frac{\text{millimeters}}{\text{inches}}$

Mounting Configurations

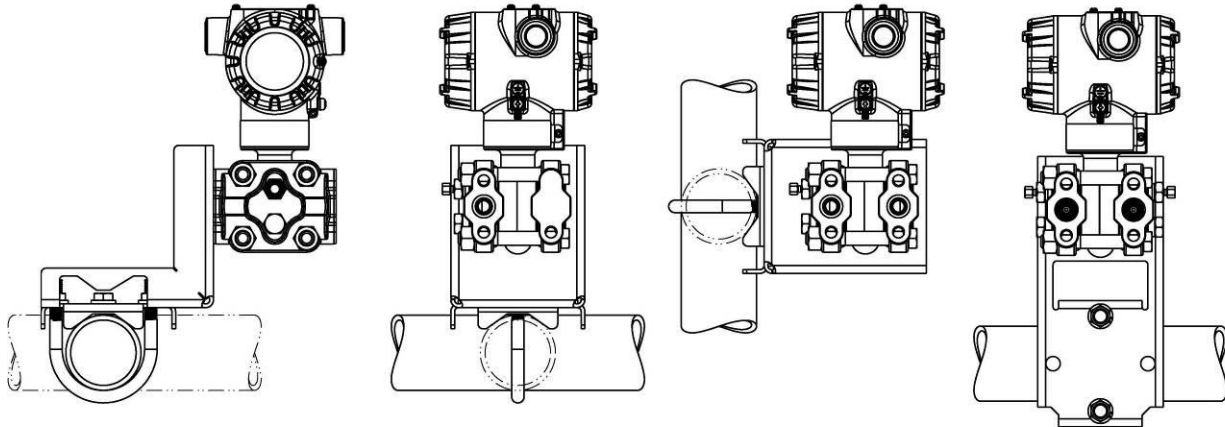

Figure 3 – Typical mounting configurations of STD720, STD730 & STD770 for reference only

Dimensions

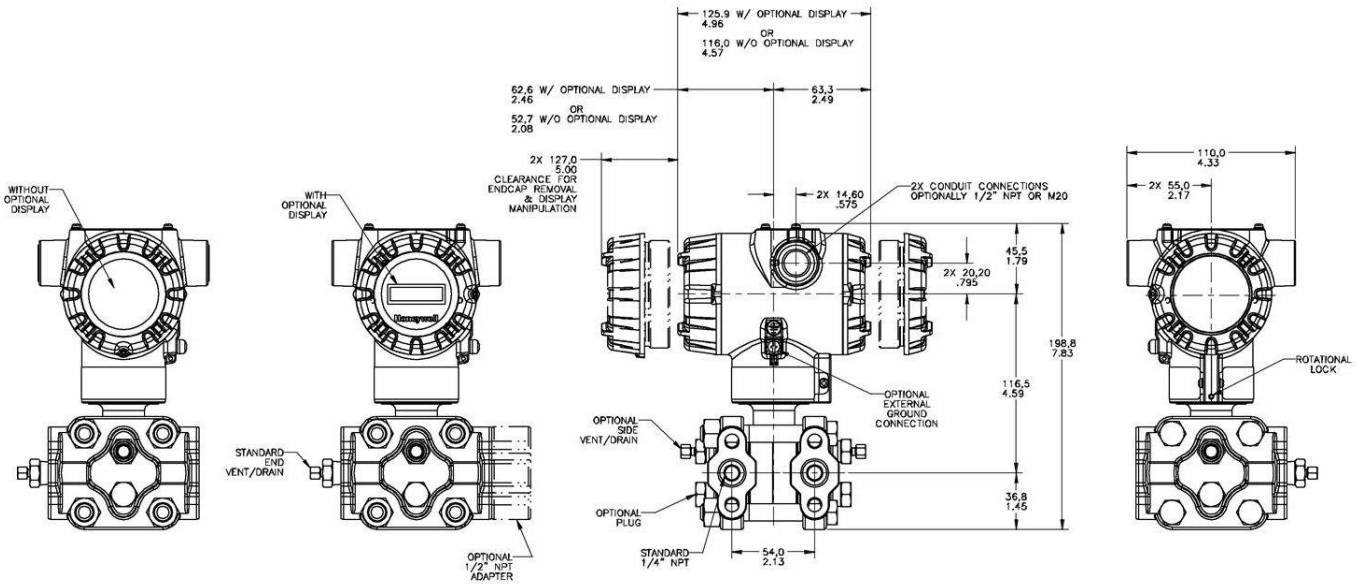

Figure 4 – Typical mounting dimensions of STD720, STD730 & STD770 for reference only

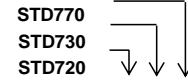
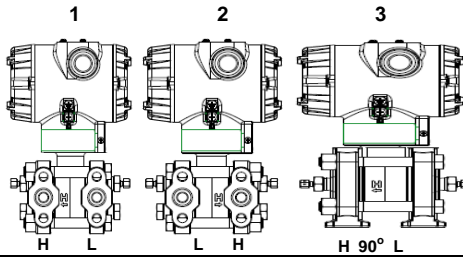

TABLE II Meter Body & Connection Orientation		
Head/Connect Orientation	Standard	High Side Left, Low Side Right ² / Std Head Orientation
	Reversed	Low Side Left, High Side Right ² / Std Head Orientation
	90/Standard	High Side Left, Low Side Right ² / 90° Head Rotation

1	*	*	*
2	*	*	*
3	h	h	h

TABLE III Agency Approvals (see data sheet for Approval Code Details)	
Approvals	No Approvals Required
	FM Explosion proof, Intrinsically Safe, Non-incendive, & Dustproof
	CSA Explosion proof, Intrinsically Safe, Non-incendive, & Dustproof
	ATEX Explosion proof, Intrinsically Safe & Non-incendive
	IECEX Explosion proof, Intrinsically Safe & Non-incendive
	SAEx Explosion proof, Intrinsically Safe & Non-incendive
	INMETRO Explosion proof, Intrinsically Safe & Non-incendive
	NEPSI Explosion proof, Intrinsically Safe & Non-incendive
	KOSHA Explosion proof, Intrinsically Safe & Non-incendive
	EAC Customs Union (Russia,Belarus,Kazakhstan) Ex Approval Flame proof, Intrinsically Safe
	ATEX/IECEX Explosion proof, Intrinsically Safe & Non-incendive
	CCoE Explosion proof, Intrinsically Safe & Non-incendive
	UATR Flameproof, Intrinsically Safe & Dustproof

0	*	*	*
A	*	*	*
B	*	*	*
C	*	*	*
D	*	*	*
E	*	*	*
F	*	*	*
G	*	*	*
H	*	*	*
I	*	*	*
1	*	*	*
J	*	*	*
K	*	*	*

TABLE IV TRANSMITTER ELECTRONICS SELECTIONS			
a. Electronic Housing Material & Connection Type	Material	Connection	Lightning Protection
	Polyester Powder Coated Aluminum	1/2 NPT	None
	Polyester Powder Coated Aluminum	M20	None
	Polyester Powder Coated Aluminum	1/2 NPT	Yes
	Polyester Powder Coated Aluminum	M20	Yes
	316 Stainless Steel (Grade CF8M)	1/2 NPT	None
	316 Stainless Steel (Grade CF8M)	M20	None
	316 Stainless Steel (Grade CF8M)	1/2 NPT	Yes
b. Output/ Protocol	Analog Output		Digital Protocol
	4-20mA dc		HART Protocol
	4-20mA dc		DE Protocol
c. Customer Interface Selections	Indicator	Ext Zero, Span & Config Buttons	Languages
	None	None	None
	None	Yes (Zero/Span Only)	None
	Advanced	None	EN, GE, FR, IT, SP, RU, TU
	Advanced	Yes	EN, GR, FR, IT, SP, RU, TU
	Advanced	None	EN, CH, JP
	Advanced	Yes	EN, CH, JP
	Standard (w/internal Zero, Span & Conf Buttons)	None	EN, RU
Standard (w/internal Zero, Span & Conf Buttons)	Yes	EN, RU	

A__	*	*	*
B__	*	*	*
C__	*	*	*
D__	*	*	*
E__	*	*	*
F__	*	*	*
G__	*	*	*
H__	*	*	*

H	*	*	*
D	*	*	*

__0	*	*	*
__A	*	*	*
__D	*	*	*
__E	*	*	*
__H	*	*	*
__J	*	*	*
__S	u	u	u
__T	u	u	u

TABLE V CONFIGURATION SELECTIONS			
a. Application Software	Diagnostics		
	Standard Diagnostics		
b. Output Limit, Failsafe & Write Protect Settings	Write Protect	Fail Mode	High & Low Output Limits ³
	Disabled	High> 21.0mAdc	Honeywell Std (3.8 - 20.8 mAdc)
	Disabled	Low< 3.6mAdc	Honeywell Std (3.8 - 20.8 mAdc)
	Enabled	High> 21.0mAdc	Honeywell Std (3.8 - 20.8 mAdc)
c. General Configuration	Factory Standard		
	Custom Configuration (Unit Data Required from customer)		

1__	*	*	*
-----	---	---	---

1	*	*	*
2	*	*	*
3	*	*	*
4	*	*	*

__S	*	*	*
__C	*	*	*

² Left side/Right side as viewed from the customer connection perspective

³ NAMUR Output Limits 3.8 - 20.5mAdc can be configured by the customer or select custom configuration Table Vc

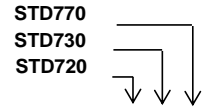

TABLE VI		CALIBRATION & ACCURACY SELECTIONS		
Accuracy and Calibration	Accuracy	Calibrated Range	Calibration Qty	
	Standard	Factory Std	Single Calibration	
	Standard	Custom (Unit Data Required)	Single Calibration	
	High Accuracy	Factory Std	Single Calibration	
	High Accuracy	Custom (Unit Data Required)	Single Calibration	

A	*	*	*
B	*	*	*
E	s	s	s
F	s	s	s

TABLE VII		ACCESSORY SELECTIONS		
a. Mounting Bracket	Bracket Type	Material		
	None	None		
	Angle Bracket	Carbon Steel		
	Angle Bracket	304 SS		
	Angle Bracket	316 SS		
	Marine Approved Bracket	Carbon Steel		
	Marine Approved Bracket	304 SS		
	Flat Bracket	Carbon Steel		
	Flat Bracket	304 SS		
	Flat Bracket	316 SS		
	b. Customer Tag	Customer Tag Type		
	No customer tag			
	One Wired Stainless Steel Tag (Up to 4 lines 26 char/line)			
	Two Wired Stainless Steel Tag (Up to 4 lines 26 char/line)			
c. Unassembled Conduit Plugs & Adapters	Unassembled Conduit Plugs & Adapters			
	No Conduit Plugs or Adapters Required			
	1/2 NPT Male to 3/4 NPT Female 316 SS Certified Conduit Adapter			
	1/2 NPT 316 SS Certified Conduit Plug			
	M20 316 SS Certified Conduit Plug			
	Minifast [®] 4 pin (1/2 NPT) (not suitable for X-Proof applications)			
	Minifast [®] 4 pin (M20) (not suitable for X-Proof applications)			

0 ___	*	*	*
1 ___	*	*	*
2 ___	*	*	*
3 ___	*	*	*
8 ___	*	*	*
4 ___	*	*	*
5 ___	*	*	*
6 ___	*	*	*
7 ___	*	*	*

_ 0 _ _	*	*	*
_ 1 _ _	*	*	*
_ 2 _ _	*	*	*

_ _ A0	*	*	*
_ _ A2	n	n	n
_ _ A6	n	n	n
_ _ A7	m	m	m
_ _ A8	n	n	n
_ _ A9	m	m	m

TABLE VIII		OTHER Certifications & Options: (String in sequence comma delimited (XX, XX, XX,...))		
Certifications & Warranty	None - No additional options			
	NACE MR0175; MR0103; ISO15156 (FC33338) Process wetted parts only			
	NACE MR0175; MR0103; ISO15156 (FC33339) Process wetted and non-wetted parts			
	Marine (DNV, ABS, BV, KR, LR)			
	EN10204 Type 3.1 Material Traceability (FC33341)			
	Certificate of Conformance (F3391)			
	Calibration Test Report & Certificate of Conformance (F3399)			
	Certificate of Origin (F0195)			
	FMEDA (SIL 2/3) Certification (FC33337)			
	Over-Pressure Leak Test Certificate (1.5X MAWP) (F3392)			
	Cert Clean for O ₂ or CL ₂ service per ASTM G93			
	PMI Certification1			
	Extended Warranty Additional 1 year			
	Extended Warranty Additional 2 years			
	Extended Warranty Additional 3 years			
	Extended Warranty Additional 4 years			

00	*	*	*	
FG	*	*	*	
F7	c	c	c	b
MT	d	d	d	
FX	*	*	*	
F3	*	*	*	b
F1	*	*	*	
F5	*	*	*	
FE	j	j	j	
TP	*	*	*	
OX	e	e	e	
PM	*	*	*	
01	*	*	*	
02	*	*	*	
03	*	*	*	b
04	*	*	*	

TABLE IX		Manufacturing Specials		
Factory	Factory Identification			

0000	*	*	*
------	---	---	---

MODEL RESTRICTIONS

Restriction Letter	Available Only with		Not Available with	
	Table	Selection(s)	Table	Selection(s)
a			VIII	F7, FG
b	Select only one option from this group			
c	1d	N, K, D, B	la	D, H, K, L
d	IV a	C, D, G, H	VIIa	1, 2, 3, 5, 6, 7
e	lb	2		
h			le	4, 5, 6
			VIIa	1, 2, 3, 4, 5, 6, 7, 8
j	IVb	H	Vb	1, 2
m	IV a	B, D, F, H		
n	IV a	A, C, E, G		
p			III	B- No CRN number available
s	I a	A, E		
t			la	J, K, L
u	IVb	H		

¹The PM option is available on all Smartline Pressure Transmitter process wetted parts such as process heads, flanges, bushings and vent plugs except plated carbon steel process heads and flanges. PM option information is also available on diaphragms except STG and STA in-line construction pressure transmitters.

FIELD INSTALLABLE REPLACEMENT PARTS

Description	Kit Number	Price
Integrally Mounted Basic Indicator Kit (Compatible with all Electronic Modules)	50049911-501	Note P
Terminal Strip w/Lightning Protection Kit for HART or DE Modules	50075472-532	Note P
Terminal Strip w/Lightning Protection Kit for FFB Module	50075472-534	Note P
Terminal Strip w/o Lightening Protection FFB Module	50075472-533	Note P
Terminal Strip w/o Lightening Protection for HART or DE Modules	50075472-531	Note P
HART Electronics Module	50049849-501	Note P
HART Electronics Module w/connection for external configuration buttons	50049849-502	Note P
DE Electronics Module	50049849-503	Note P
DE Electronics Module w/connection for external configuration buttons	50049849-504	Note P
FFB Electronics Module Kit	50049849-509	Note P
FFB Electronics Module w/connection for external configuration buttons	50049849-510	Note P
Standard Display Module	50126003-501	Note P

Note P - For part number pricing please refer to WEB Channel

PRODUCT MANUALS

Description	Part Number
Product Manual ST 700 Smart Transmitter User Manual - English	34-ST-25-44
Product Manual ST 700 Smart Transmitter HART/DE Communications Manual - English	34-ST-25-47
Product Manual ST 700 Smart Transmitter Safety Manual - English	34-ST-25-37
Product Manual ST 700 Smart Transmitter Foundation Fieldbus Manual - English	34-ST-25-48
Product Manual ST 700 Smart Transmitter Function Block Manual - English	34-ST-25-49

All product documentation is available at www.process.honeywell.com.

Sales and Service

For application assistance, current specifications, ordering, pricing, and name of the nearest Authorized Distributor, contact one of the offices below.

ASIA PACIFIC

Honeywell Process Solutions,
Phone: + 800 12026455 or
+44 (0) 1202645583
(TAC) hfs-tac-support@honeywell.com

Australia

Honeywell Limited
Phone: +(61) 7-3846 1255
FAX: +(61) 7-3840 6481
Toll Free 1300-36-39-36
Toll Free Fax:
1300-36-04-70

China – PRC - Shanghai

Honeywell China Inc.
Phone: (86-21) 5257-4568
Fax: (86-21) 6237-2826

Singapore

Honeywell Pte Ltd.
Phone: +(65) 6580 3278
Fax: +(65) 6445-3033

South Korea

Honeywell Korea Co Ltd
Phone: +(822) 799 6114
Fax: +(822) 792 9015

EMEA

Honeywell Process Solutions,
Phone: + 800 12026455 or
+44 (0) 1202645583

Email: (Sales)

FP-Sales-Apps@Honeywell.com

or

(TAC)

hfs-tac-support@honeywell.com

Web

Knowledge Base search
engine <http://bit.ly/2N5Vldi>

AMERICAS

Honeywell Process Solutions,
Phone: (TAC) (800) 423-9883
or (215) 641-3610
(Sales) 1-800-343-0228

Email: (Sales)

FP-Sales-Apps@Honeywell.com

or

(TAC)

hfs-tac-support@honeywell.com

Web

Knowledge Base search
engine <http://bit.ly/2N5Vldi>

Specifications are subject to change without notice.

For more information

To learn more about SmartLine Pressure
Transmitters visit www.process.honeywell.com
Or contact your Honeywell Account Manager

Process Solutions

Honeywell
1250 W Sam Houston Pkwy S
Houston, TX 77042

Honeywell Control Systems Ltd
Honeywell House, Skimped Hill Lane
Bracknell, England, RG12 1EB

Shanghai City Centre, 100 Jungi Road
Shanghai, China 20061

www.process.honeywell.com

Authorized Distributor:

 **De Gidts & Feldman**

INSTRUMENTATION & FILTRATION

De Gidts & Feldman B.V.
Almere – The Netherlands

E-mail sales@dgfg.nl

Website www.dgfg.nl

Honeywell

34-ST-03-101
March 2024

©2024 Honeywell International Inc.